

**AMES AREA METROPOLITAN PLANNING ORGANIZATION
REGIONAL INTELLIGENT TRANSPORTATION SYSTEMS
ARCHITECTURE**

Version 1.0

Prepared for:



Prepared by:



January 2007

Page Left Blank Intentionally

Table of Contents

List of Figures	ii
List of Tables	iii
Executive Summary	v
1. Introduction	1
1.1 Vision, Mission, and Objectives	1
1.2 Description of the Region	2
1.3 Organization of the Report.....	4
2. Regional ITS Architecture Development Process	6
2.1 Architecture Development Process.....	6
2.2 Requirements of the Final FHWA Rule and FTA Policy on Architecture	8
3. Stakeholders and Operational Concept	9
3.1 Identification of Participating Agencies and Stakeholders	9
3.2 Operational Concept	11
4. Inventory	21
5. Market Packages	32
5.1 Identification of Market Packages	32
5.2 Customization of Market Packages	38
6. Subsystems, Equipment Packages and Functional Requirements	44
6.1 Mapping of Market Packages to Subsystems and Equipment Packages	44
6.2 Functional Requirements	48
7. Interconnects and Architecture Flows	51
7.1 System Interconnects	51
7.2 Architecture Flows.....	60
7.3 High-Level Architectures for Selected Projects	68
8. ITS Standards	74
8.1 Standards Benefits	74
8.2 Using Standards	75
8.3 Mapping of Recommended Standards to Application Areas.....	79
9. Project Sequencing	88
10. Agreements	93
11. Using Regional ITS Architecture	98
11.1 Support Transportation Planning Process.....	98

11.2 Support ITS Project Development	99
12. Architecture Maintenance Plan.....	102
12.1 Introduction.....	102
12.2 Who Is Responsible for Architecture Maintenance	103
12.3 What Will Be Maintained	103
12.4 Configuration Control.....	104
13. Glossary and Definition.....	106

Appendices

Appendix A: Stakeholder Survey Questionnaire.....	A-1
Appendix B: Functional Requirements.....	B-1
Appendix C: Architecture Interconnect Diagrams	C-1
Appendix D: Architecture Flows	D-1

List of Figures

Figure 1-1. AAMPO Boundary.....	3
Figure 2-1. Architecture Development Process	7
Figure 7-1. AAMPO Regional ITS Architecture Sausage Diagram.....	52
Figure 7-2. Interconnect Diagram: City of Ames Public Works	53
Figure 7-3. Interconnect Diagram: City of Ames CyRide.....	54
Figure 7-4. Interconnect Diagram: City of Ames Police Communications Center	55
Figure 7-5. Interconnect Diagram: Story County Sheriff Communications Center	56
Figure 7-6. Interconnect Diagram: Iowa State University Police Communications Center.....	57
Figure 7-7. Interconnect Diagram: Iowa State Patrol Des Moines Communications Center	58
Figure 7-8. Interconnect Diagram: Iowa DOT Ames Maintenance Garage	59
Figure 7-9. Architecture Flow Diagram: City of Ames Public Works	61
Figure 7-10. Architecture Flow Diagram: City of Ames CyRide.....	62
Figure 7-11. Architecture Flow Diagram: Story County Sheriff Communications Center	63
Figure 7-12. Architecture Flow Diagram: City of Ames Police Communications Center	64
Figure 7-13. Architecture Flow Diagram: Iowa State University Police Communications Center	65
Figure 7-14. Architecture Flow Diagram: Iowa State Patrol Des Moines Communications Center	66
Figure 7-15. Architecture Flow Diagram: Iowa DOT Ames Maintenance Garage.....	67
Figure 7-16. Project Architecture: Iowa DOT CCTV on RWIS Tower	68
Figure 7-17. Project Architecture: Iowa DOT Permanent DMS	69
Figure 7-18. Project Architecture: Iowa DOT Precipitation and Visibility Sensors	70
Figure 7-19. Project Architecture: Iowa DOT Speed Sensors at RWIS Site.....	71

Figure 7-20. Project Architecture: City of Ames CyRide Transit AVL System	71
Figure 7-21. Project Architecture: City of Ames CyRide Transit Vehicle On-board Security Cameras.....	72
Figure 7-22. Project Architecture: Consolidated 911 Computer Aided Dispatch	73

List of Tables

Table 2-1. Mapping of Requirements to Architecture Outputs	8
Table 3-1. AAMPO Regional ITS Architecture Stakeholders.....	9
Table 3-2. Operational Concept for AAMPO Regional ITS Architecture	12
Table 4-1. AAMPO Regional ITS Inventory.....	22
Table 5-1. Mapping of ITS Inventory to Market Packages	33
Table 5-2. List of Market Packages for AAMPO Regional ITS Architecture.....	36
Table 5-3. List of Market Packages by Architecture Elements	38
Table 6-1. Market Packages, Subsystems and Equipment Packages.....	45
Table 6-2. Functional Requirements Example: City of of Ames Public Works Network Surveillance.....	50
Table 8-1. Standards Supporting the AAMPO Regional ITS Projects.....	76
Table 8-2. Key ITS Standards Application Area Matrix for AAMPO Region	81
Table 9-1. Planned ITS Projects for AAMPO Regional ITS Architecture.....	89
Table 10-1. Types of Agreements.....	94
Table 10-2. AAMPO Regional ITS Architecture Existing/Potential Agreements	95
Table 11-1. Systems Engineering Requirements Supported by Regional ITS Architecture	101

Page Left Blank Intentionally

EXECUTIVE SUMMARY

The Ames Area Metropolitan Planning Organization (AAMPO) Regional Intelligent Transportation Systems (ITS) Architecture is a roadmap for intelligent transportation systems deployment and integration within the AAMPO region. An ITS architecture describes the “big picture” for ITS deployment in terms of individual components (i.e. subsystems) that will perform the functions necessary to deliver the desired needs. An ITS architecture supports effective and efficient deployment of transportation and ITS projects that address the transportation problems and needs. The architecture represents a shared vision of how each agency’s systems will work together in the future, sharing information and resources to provide a safer, more efficient, and more effective transportation system for travelers in the region. The architecture is a living document and will change as stakeholders and needs change.

VISION, MISSION, AND OBJECTIVES

Stakeholders within the region have recognized the need for vision and strategic planning with respect to ITS technology. The vision for the AAMPO Regional ITS Architecture is one of enhanced transportation productivity, mobility, safety, efficiency and security through the use of integrated, cost-effective ITS technologies and systems and strong operational relationships.

The mission for the AAMPO Regional ITS Architecture is to develop an open and integrated ITS architecture that is compliant with the Federal Highway Administration (FHWA) Final Rule and Federal Transit Administration (FTA) Policy on ITS Architecture and Standards to support existing and future ITS projects and enhance compatibility of existing regional and project ITS architectures within Iowa and emerging national ITS architecture.

Eight objectives were established as a means towards realization of the mission statement above:

- Establish an ITS architecture that: is open, receptive and adaptable; is consistent with developing national standards; provides opportunities for private/public partnerships; and encourages and supports interagency cooperation;
- Develop and integrate traveler information, traffic management, public transportation management, maintenance and construction management, and emergency management systems throughout the region as appropriate.
- Define how information is collected, processed, distributed and disseminated.
- Define interfaces and information flow among/between subsystems, agencies, and users.
- Support transportation planning process for ITS projects for the AAMPO;
- Support development of strategies and actions in planning process that lead to an integrated, efficient intermodal transportation system;
- Support development of ITS projects; and
- Assist in developing, prioritizing, and addressing consistency of proposed transportation investment.

ARCHITECTURE DEVELOPMENT PROCESS

The process for developing the AAMPO Regional ITS Architecture is based on the National ITS Architecture developed by the United States Department of Transportation (USDOT). Compliance with the National Architecture is mandatory, as part of the Final Rule published by the FHWA and FTA on January 8, 2001 for receiving Federal funds for ITS projects. By taking advantage of the USDOT's National ITS Architecture and developing a regional ITS architecture that is consistent with the National ITS Architecture, the region will be able to take advantage of the growing supplier/vendor market for ITS products and services.

Development of the regional ITS architecture begins with the identification of stakeholders and their needs. The objective of identifying stakeholders is to identify and engage stakeholders that own or operate ITS systems and other agencies that have an interest in the transportation issues within the region. Information on existing and planned ITS projects within the region was collected through a comprehensive stakeholder survey. The survey results were then compiled and used as an "entrance" into the regional ITS architecture. In addition, the existing planning documents also provide resources to support the development of the regional ITS architecture.

OPERATIONAL CONCEPT

The AAMPO Regional ITS Architecture is intended to facilitate data sharing and cooperative control among ITS subsystems throughout the region. The architecture defines an operational concept that describes each stakeholder's current and future roles and responsibilities in the implementation and operation of ITS systems within the region. The architecture describes and categorizes the stakeholders' roles and responsibilities in nine transportation service areas. These transportation service areas provide general classifications of what functions the participating agencies are providing or will provide. The nine transportation service areas are:

- Archived data management
- Commercial vehicle operations
- Emergency management
- Incident management
- Maintenance and construction management
- Public transportation
- Traffic management
- Traveler information
- Transportation planning and architecture maintenance.

REGIONAL ITS ARCHITECTURE

The regional ITS architecture describes coordination of overall system operations by defining interfaces between equipment and systems which have been and will be deployed by different organizational or operating agencies throughout the region. The architecture identifies the current ITS deployment and how these systems interact and talk with each other. It also builds on the existing systems and addresses the additional components deemed necessary to grow the

ITS systems in the region over the next 10 years to accommodate specific needs and issues of participating stakeholders.

A high-level interconnect diagram for the AAMPO Regional ITS Architecture, often referred to as a “sausage diagram” as shown below, illustrates the architecture subsystems and primary types of interconnections (or communications) between these subsystems. The sausage diagram was customized to reflect the systems of the regional ITS architecture. The shaded areas indicate the functions and services that are not currently existing and planned in the region.

This diagram shows the four main parts (Travelers, Centers, Vehicles, and Field) of an intelligent transportation system and how each can communicate with each other.

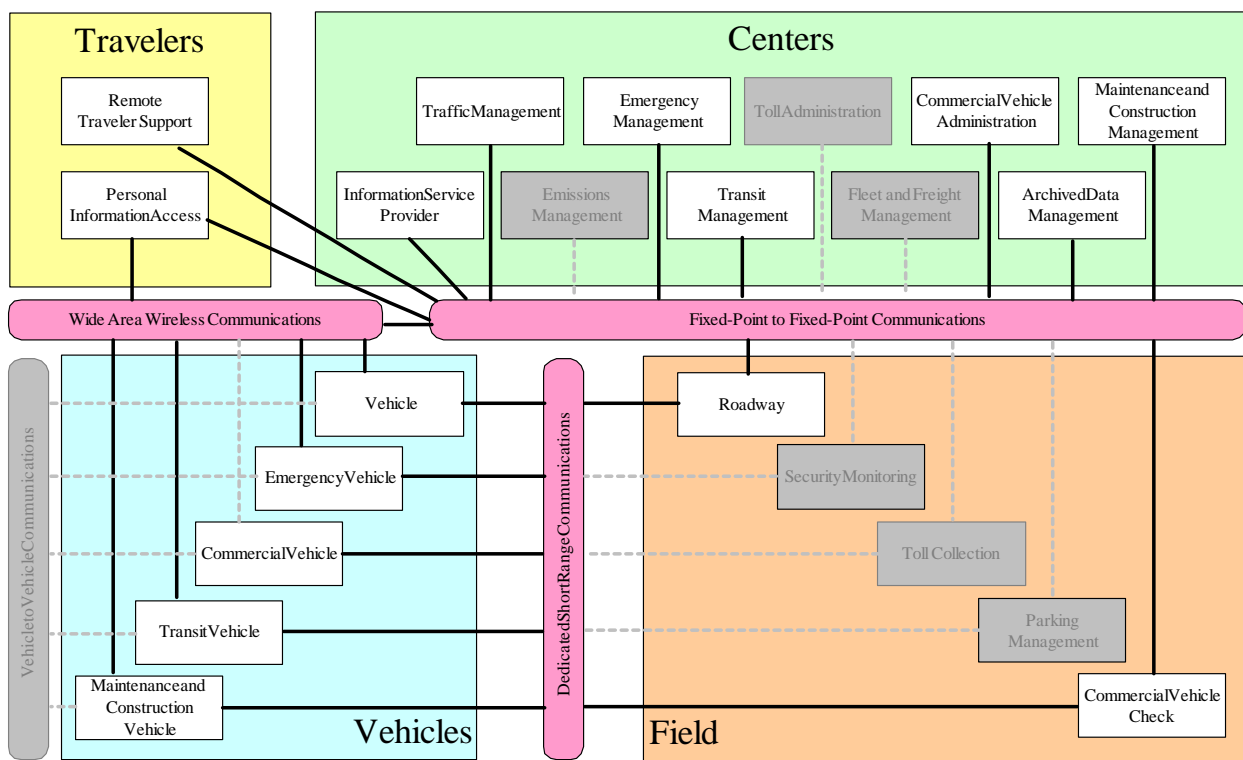

HIGH-LEVEL ARCHITECTURE FOR PLANNED PROJECTS

High-level project architectures have been developed for the planned projects identified in the regional ITS architecture. Planned projects have been phased into three primary time frames: near-term, medium-term, and long-term. The project architectures illustrate the interfaces and interactions between the subsystem/terminators for the planned projects. Descriptions and illustrations of architectures for the selected planned ITS projects are provided in the AAMPO Regional ITS Architecture Report. Architectures for all planned projects are documented in the accompanied Turbo Architecture database.

APPLICABLE ITS STANDARDS

ITS Standards are fundamental to the establishment of an open ITS environment that achieves the goals originally envisioned by the USDOT. Standards facilitate deployment of interoperable systems at local, regional, and national levels without impeding innovation as technology advances and new approaches evolve. Standards can be thought of as the glue that holds the various pieces of architecture together. They define how the communications within an ITS environment take place.

While the AAMPO Regional ITS Architecture is a comprehensive plan which includes various ITS applications, it does not cover every conceivable ITS technology. As such, not all ITS standards will be applicable to the existing and planned projects. Seventy-two (72) ITS standards were identified as key standards supporting the ITS projects in the region. A guide to the key ITS standards that should be considered for use in different types of ITS projects in the region was developed in terms of an application area matrix on pages 81 to 87. Nineteen (19) application areas are included in the matrix. The application areas are deployment-oriented categories that focus on specific ITS services or systems. They can assist deployers in finding the application area within which a particular ITS project fits.

PROJECT SEQUENCE

The AAMPO Regional ITS Architecture recommends a sequence in which ITS projects may be implemented. The project implementation sequence is recommended based on a combination of two factors:

- **Prioritization of projects based on existing conditions and stakeholder needs.** ITS projects were prioritized to reflect a deployment path (sequence) on stakeholder needs. As technology, funding opportunities and requirements continue to evolve, it is expected that stakeholders will reevaluate and reprioritize projects frequently.
- **Project dependencies, based on how successive ITS projects can build upon one another.** Project dependencies influence the project sequencing. It is beneficial to identify the information and functional dependencies between projects based on the regional ITS architecture and any other external dependencies that affect the project sequence.

AGREEMENTS REQUIRED FOR IMPLEMENTATION AND OPERATION

The AAMPO Regional ITS Architecture provides both a technical and institutional framework for the deployment of ITS in the region. Institutional integration involves cooperation and coordination between various agencies and jurisdictions to achieve seamless operations and interoperability. There is considerable variation between ITS projects and among stakeholders regarding the types of agreements that are created to support ITS integration. Information sharing and exchanges between systems require knowledge of the transmission protocol and data formats to ensure compatibility. Coordinating field device operations owned by different agencies requires defined procedures for submitting message requests and rules governing when such

requests can be honored. While all interfaces involve agreements for data compatibility, agreements for procedure, operation, and maintenance as well as training may also be critical elements to optimizing the benefits of the architecture. The regional ITS architecture identifies and summarizes common types of agreements required for the implementation and operation of ITS projects and systems.

IMPLEMENTATION AND INTEGRATION STRATEGIES

The AAMPO Regional ITS Architecture provides guidance for planning ITS projects within the region. It represents a detailed plan for the evolution of the ITS systems in the region and can be used to support transportation planning efforts and ITS project development efforts. In addition, the regional ITS architecture can be used for support in ITS project development cycle. It provides information that can be used in the initial stages of project definition and development. A typical ITS project development cycle begins with project definition, followed by Request for Proposal (RFP) generation, leading to project implementation. Information in the regional ITS architecture can assist in all three of these areas of project development.

A regional ITS architecture focuses on the integration of systems to gain the maximum benefit of each system's information and capabilities across the transportation network. The most challenging issue in the integration of an ITS architecture in the planning process is the fact that there is more than one planning process. Coordination among the AAMPO, the Central Iowa Region Transportation Planning Alliance (Regional Planning Affiliation 11), and the Iowa Department of Transportation for ITS projects in their respective plans is critical to the success of ITS planning, deployment, and integration. Integration opportunities should be taken advantage of within the region. This is the primary intent of the ITS architecture compliance where Federal funding is involved.

DOCUMENTATION OF ITS ARCHITECTURES

The AAMPO Regional ITS Architecture is documented in two forms. The first is this document, which provides an overview of the architecture and summary information regarding various aspects of the architecture. The second form of documentation is the Turbo Architecture database. The database prepared using the Turbo Architecture, a software tool developed by FHWA, captures the details of the regional ITS architecture including definition of stakeholders, inventory, projects, operational concept, market packages, equipment packages, interconnects, interfaces, functional requirements, standards, and agreements.

ARCHITECTURE MAINTENANCE

By its nature, an ITS architecture is not a static set of outputs. The AAMPO Regional ITS Architecture is a living document and should be modified as plans and priorities change, ITS projects are implemented, and the ITS needs and services evolve in the region. An architecture maintenance plan is developed to address the needs for maintenance and updates. The architecture maintenance plan defines the key aspects of the process for updating and maintaining the regional ITS architecture, including:

- Who is responsible for architecture maintenance?
- What will be maintained?
- How will it be maintained?

It is recommended that the AAMPO to be responsible for all aspects of maintenance for the regional ITS architecture.

1. INTRODUCTION

An Intelligent Transportation Systems (ITS) architecture describes the “big picture” for ITS deployment in terms of individual components (i.e. subsystems) that will perform the functions necessary to deliver the desired needs. It describes what is to be deployed but not how those systems are to be deployed. An ITS architecture will define the components and subsystems that must interface with each other, the functions to be performed by those subsystems and the data flows among these subsystems.

The Ames Area Metropolitan Planning Organization (AAMPO) Regional ITS Architecture is a roadmap for transportation systems deployment and integration in the Ames metropolitan area. The architecture has been developed through a cooperative effort by the transportation and emergency management agencies, covering all modes and all roads in the region. The architecture represents a shared vision of how each agency’s systems will work together in the future, sharing information and resources to provide a safer, more efficient, and more effective transportation system for travelers in the region.

The timeframe considered for this architecture is a 10-year vision for ITS activities in the region. This means that the AAMPO Regional ITS Architecture addresses existing ITS systems as well as those planned for development over the next 10 years (2005 – 2014). It represents a snapshot of the currently anticipated projects based on information from stakeholders. As such, the architecture will require regular updates to ensure that it maintains accurate representation of the region.

The process for developing the AAMPO Regional ITS Architecture is based on the National ITS Architecture developed by the United States Department of Transportation (USDOT). Compliance with the National ITS Architecture is mandatory, as part of the Final Rule published by the Federal Highway Administration (FHWA) and Federal Transit Administration (FTA) on January 8, 2001 for receiving Federal funds for ITS projects. By taking advantage of the USDOT’s National ITS Architecture and developing a regional ITS architecture that is consistent with the National ITS Architecture, the AAMPO region will be able to take advantage of the growing supplier/vendor market for ITS products and services. As the standards are implemented across the nation, economies of scale will be realized in the purchase and development of ITS related products and services.

1.1 Vision, Mission, and Objectives

Vision

Stakeholders in the region have recognized the need for vision and strategic planning with respect to ITS technology. The vision for the AAMPO Regional ITS Architecture is one of enhanced transportation productivity, mobility, safety, efficiency and security through the use of integrated, cost-effective ITS technologies and systems and strong operational relationships.

Mission

The mission for the AAMPO Regional ITS Architecture is to develop an open and integrated ITS architecture that is compliant with the FHWA Final Rule and FTA Policy on ITS Architecture

and Standards to support existing and future ITS projects and enhance compatibility of existing architectures within the region and emerging national ITS architecture

Objectives

Eight objectives were established as a means towards realization of the mission statement above. They are:

- Establish an ITS architecture that: is open, receptive and adaptable; is consistent with developing national standards; provides opportunities for private/public partnerships; and encourages and supports interagency cooperation;
- Develop and integrate traveler information, traffic management, public transportation management, maintenance and construction management, and emergency management systems throughout the region as appropriate;
- Define how information is collected, processed, distributed and disseminated;
- Define interfaces and information flow among/between subsystems, agencies, and users;
- Support transportation planning process for ITS projects for the AAMPO;
- Support development of strategies and actions in planning process that lead to an integrated, efficient intermodal transportation system;
- Support development of ITS projects; and
- Assist in developing, prioritizing, and addressing consistency of proposed transportation investment.

1.2 Description of the Region

The Ames Urbanized Area has been established by the U.S. Department of Commerce, Bureau of Census, to have a population in excess of 50,000, and the AAMPO has been officially designated as the Metropolitan Planning Organization (MPO) for the Ames area in 2002. As illustrated in Figure 1-1, the geographical boundary of the AAMPO region covers the entire City of Ames, and a portion of Story County and Boone County.

The population of the Ames area was approximately 52,300 in 2004, which included student enrollment at the Iowa State University. The region is served by a number of major highways. These include I-35, US 30, and US 69. Some of the major arterials within the City of Ames include Lincoln Way, Grand Avenue, 13th Street, South Duff Avenue, Duff Avenue, South Dakota Avenue, Stange Road, and Elwood Drive. The City of Ames currently has 56 traffic signals, 7 school crossing signals, 4 school flashers, and 6 railroad crossing automated horn warning systems. The Iowa Department of Transportation (DOT) Headquarters are located in the City of Ames. The AAMPO area is within the jurisdiction of the Iowa DOT District 1.

The City of Ames CyRide and Heart of Iowa Regional Transit Agency (HIRTA) are the two major transit service providers in the area. The City of Ames CyRide provides bus services in the city, including fixed routes services, a dial-a-ride service for persons with a disability, a late night service (called Moonlight Express), and a shuttle service to Des Moines Airport. The CyRide operates 66 buses and provides service to approximately 4.3 million passengers. The HIRTA serves as the Regional Transit Authority for Region 11 which covers seven counties including Boone, Dallas, Jasper, Madison, Marion, Story, and Warren. The HIRTA provides

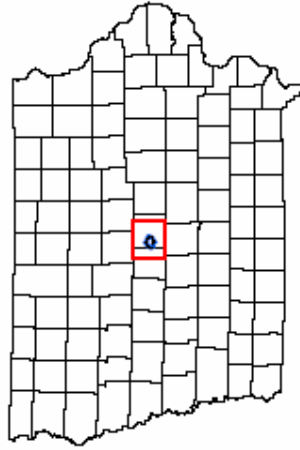
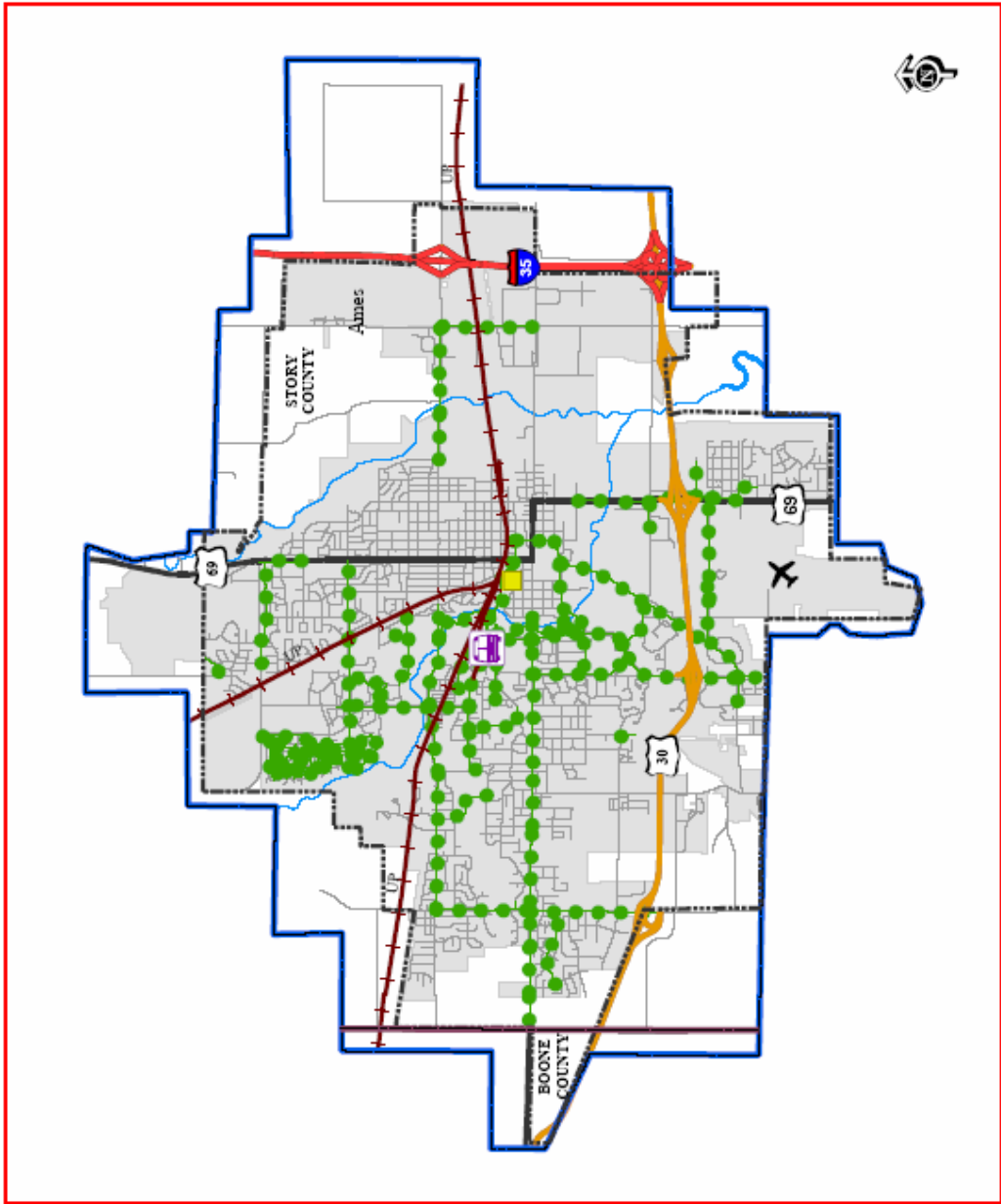

- Commercial Airport
- Enhanced Airport
- General Service Airport
- Basic Service Airport
- Basic II Service Airport
- Interstates
- National Highway System
- Primary Roads
- Local Roads
- Large Urban Transit
- Small Urban Transit
- Regional Transit
- Intercity Bus Stop
- Amtrak Station
- Rail
- Trails
- Lock/Dam
- MPO Boundary
- County Boundary
- Urban Area Boundary
- City Boundary

Figure 1-1. AAMPO Boundary

transit services through individual social service transportation providers in each of its counties. Boone County Transportation and Heartland Senior Services, Inc., both are contracted with the HIRTA, are the providers which offer demand responsive bus services to Boone County and Story County, respectively.

The Ames Municipal Airport serves as a general aviation airport for the region. The region is also served by several rail lines operated by the Union Pacific Railroad.

1.3 Organization of the Report

This report is organized based on the general process for the development of the AAMPO Regional ITS Architecture. The major sections of the report are summarized as the following:

- **Section 1 - Introduction:** This section identifies the vision, mission, and objectives of the AAMPO Regional ITS Architecture. It also provides a general description of the area covered in the regional ITS Architecture.
- **Section 2 – Regional ITS Architecture Development Process:** This section describes process for developing the AAMPO Regional ITS Architecture and summarizes the requirements of the final FHWA Rule and FTA policy on ITS Architecture and Standards.
- **Section 3 – Stakeholders and Operational Concept:** This section identifies and describes participating agencies and stakeholders and their roles and responsibilities in the operation and implementation of the ITS systems and/or components within the region.
- **Section 4 – Inventory:** This section identifies the existing and planned ITS elements within the region.
- **Section 5 – Market Packages:** This section identifies a list of market packages that are applicable to the region. The market packages provide a collection of service-oriented technology bundles that can be incorporated in the development of the regional ITS architecture.
- **Section 6 – Subsystems, Equipment Packages and Functional Requirements:** The customized list of market packages developed in Section 5 was used to define the subsystems, equipment packages, and functional requirements that are necessary for the implementation of the customized market packages.
- **Section 7 – Interconnects and Architecture Flows:** This section describes the physical architecture by defining interfaces between equipment and systems that may be deployed by different organizational or operating agencies throughout the region.
- **Section 8 – ITS Standards:** This section describes a list of key standards that support the implementation of the regional ITS architecture.

- **Section 9 – Project Sequencing:** This section provides an implementation strategy as well as a recommended sequencing for implementing ITS project in the region over the next 10 years.
- **Section 10 – Agreements:** This section identifies and summarizes a list of agreements between agencies that may be required for operations.
- **Section 11 – Using Regional ITS Architecture:** This section describes the relationship between a regional ITS architecture and transportation planning process. It summarizes how a regional ITS architecture is used to assist in transportation planning and project implementation.
- **Section 12 – Architecture Maintenance Plan:** This section describes a process for controlled updates to the regional ITS architecture baseline so that the architecture continues to accurately reflect the region’s current ITS capabilities and future plans.
- **Section 13 – Glossary and Definition:** This section defines ITS related terms used throughout this report.

2. REGIONAL ITS ARCHITECTURE DEVELOPMENT PROCESS

2.1 Architecture Development Process

The process used to develop the AAMPO Regional ITS Architecture is illustrated in Figure 2-1. Figure 2-1 shows six general steps in the “lifecycle” of a regional ITS architecture. Through the first four steps, the regional ITS architecture products are developed and then these products are used and maintained in steps 5 and 6. The development process begins with basic scope definition and team building and moves through increasingly detailed steps, culminating in specific products that will guide the “implementation” of the regional ITS architecture.

Development of the AAMPO Regional ITS Architecture begins with the identification of stakeholders and their needs. The success of a regional ITS architecture depends on participation by a diverse set of stakeholders. The objective of identifying stakeholders is to identify and engage stakeholders that own or operate ITS systems and other agencies that have an interest in the transportation issues within the region.

Information on existing and planned ITS projects within the region was collected through a comprehensive stakeholder survey. The survey results were then compiled and used as an “entrance” into the National ITS Architecture and mapped against the Market Packages and the physical architecture defined in the National ITS Architecture. A market package is a “bundle” of technology services that is often purchased together as a group to provide the functions necessary to deploy the services. The selection of market packages allows for the identification of equipment packages and subsystems – a collection of building blocks for the development of an ITS architecture. The physical architecture defines the Physical Entities (Subsystems and Terminators) that make up an intelligent transportation system. It defines the Architecture Flows that connect the various Subsystems and Terminators into an integrated system.

An ITS architecture coordinates overall system operation by defining interfaces between equipment and systems (interconnect and architecture flows). These interfaces describe the functions of the systems by showing the information that flows between various systems and subsystems.

Upon identification of the system interfaces, additional products were defined to guide the implementation of planned ITS projects. These products include a sequence of projects, list of agency agreements required for operations, and a list of ITS standards that shall be considered for project implementation.

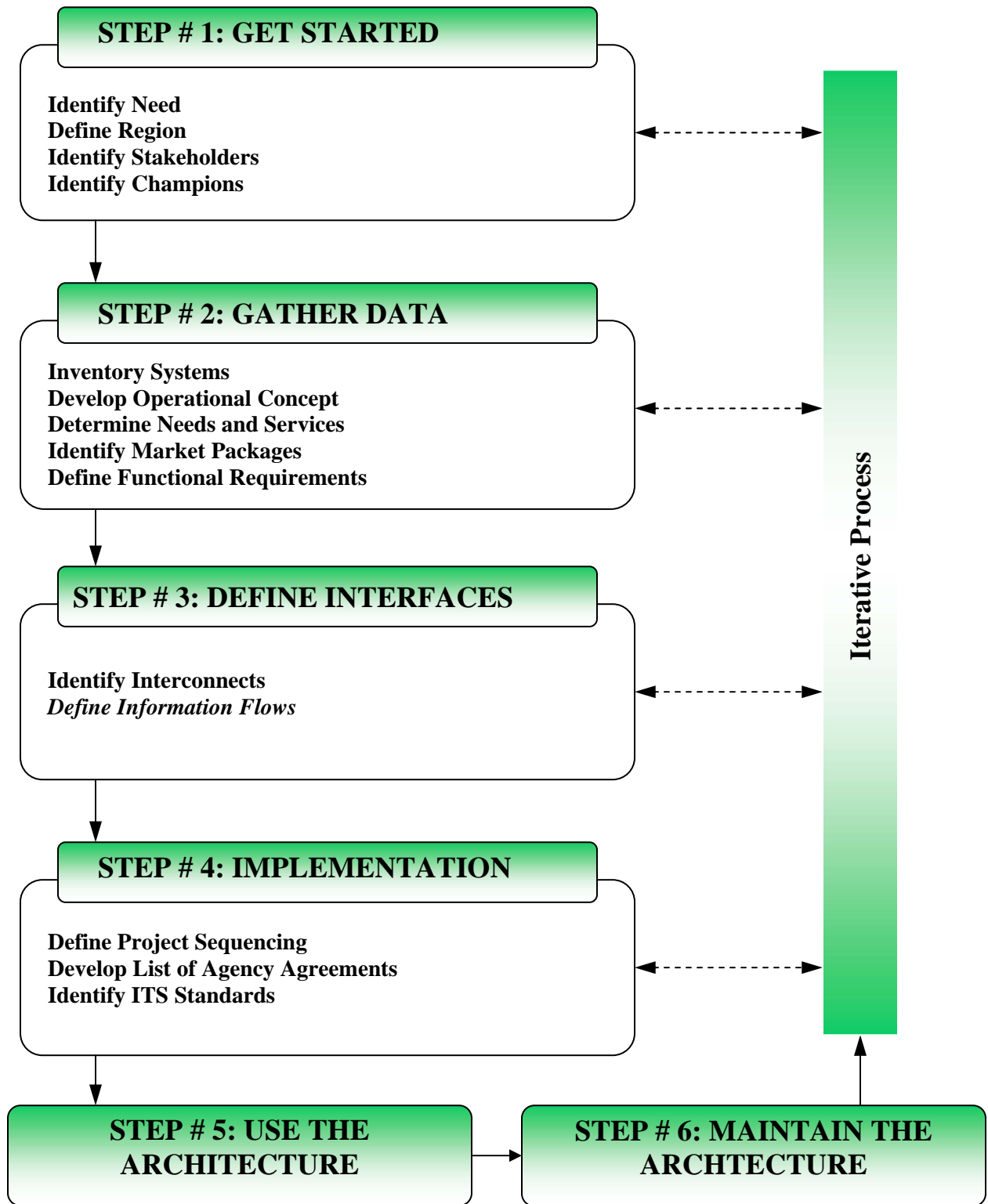

Figure 2-1. Architecture Development Process

2.2 Requirements of the Final FHWA Rule and FTA Policy on Architecture

The FHWA Final Rule (23CFR 940) and FTA Policy on ITS Architecture and Standards, which took effect on April 8, 2001, defines a set of requirements that regional ITS architectures should meet. The FHWA Final Rule and FTA Final Policy state that – “ITS projects shall conform to the National ITS Architecture and Standards in accordance with the requirements. Conformance with the National ITS Architecture is interpreted to mean the use of the National ITS Architecture to develop a regional ITS architecture, and the subsequent adherence of all ITS projects to that regional ITS architecture. Development of the regional ITS architecture should be consistent with the transportation planning process for Statewide and Metropolitan Transportation Planning.” Table 2-1 shows how the requirements of the rule are met by the outputs developed for the AAMPO Regional ITS Architecture.

Table 2-1. Mapping of Requirements to Architecture Outputs

Statewide/Regional ITS Architecture Requirements	Where Requirements documented
Description of region	Geographic definition, as well as timeframe and scope of services are given in Section 1 of this document.
Identification of participating agencies and other stakeholders	Listing of stakeholders and their definitions is given in Section 3.1 of this document. An inventory of the elements operated by the stakeholders is contained in Section 4 of this document.
An operational concept that identifies the roles and responsibilities of participating agencies and stakeholders	The operational concept is defined in Section 3.2 of this document.
A list of any agreements (existing or new) required for operations	A discussion of existing and needed new agreements is given in Section 10 of this document.
System functional requirements	The functional requirements of the ITS systems are described in an overview in Section 7 of this document, and are provided in detail in the Turbo Architecture database.
Interface requirements and information exchanges with planned and existing systems and subsystems	The Interfaces and information flows are described in an overview in Section 6 of the document, and are described in detail in the Turbo Architecture database.
Identification of ITS standards supporting regional and national interoperability	An overview of the ITS standards is given in Section 8 of the document. The detailed listing of ITS standards applicable to each interface in the architecture is described in the Turbo Architecture database.
The sequence of projects required for implementation	Projects and their sequencing are covered in Section 9 of this document.

As summarized in Table 2-1, this document, in conjunction with the Turbo Architecture database for the AAMPO Regional ITS Architecture, satisfies the mandatory requirements defined in the ITS Architecture and Standards Final Rule and Policy set forth by the FHWA and FTA.

3. STAKEHOLDERS AND OPERATIONAL CONCEPT

3.1 Identification of Participating Agencies and Stakeholders

Stakeholders are commonly considered to be those who own or operate ITS systems in the region as well as those who have an interest in regional transportation issues. As stakeholders provide crucial input regarding the region’s transportation investment and ITS deployments, stakeholder participation and coordination is critical to the success of the ITS architecture development. Through an extensive outreach process, including stakeholder meetings and stakeholder surveys, participating agencies and stakeholders for the AAMPO Regional ITS Architecture were identified. The AAMPO Regional ITS Architecture includes a wide range of stakeholders. Table 3-1 lists the agencies and stakeholders participated in the implementation and operation of the ITS projects in the region.

Table 3-1. AAMPO Regional ITS Architecture Stakeholders

Stakeholder	Description
Ames Area Metropolitan Planning Organization	Serves as the MPO for the Ames urbanized area and provides transportation planning and technical assistance services to various agencies within the region.
Iowa Department of Transportation	The Iowa DOT plans, constructs, maintains and improves the state’s road and bridges, and provides planning and financial support for other modes of transportation. The AAMPO area is under Iowa DOT District 1’s jurisdiction which serves 12 counties of Boone, Greene, Grundy, Hamilton, Hardin, Jasper, Marshall, Polk, Poweshiek, Story, Tama and Webster. District 1 includes 3 construction offices, 17 maintenance garages and 1 material office.
Iowa State Patrol	A division of the Iowa Department of Public Safety which routinely patrols state roadways, including interstates, state highways and secondary county roads, enforces motor vehicle laws, and assists in major incidents. The AAMPO area is under the jurisdiction of the Iowa State Patrol District 1. The State Patrol Des Moines Communications Center responds to 911 calls and calls to the Iowa State Patrol Help Line from the Ames MPO area.
City of Ames Police Department	City law enforcement and emergency response. The department has a communications center to respond to 911 emergency calls for the city and portions of Story County.
City of Ames Fire Department	Provides fire prevention and suppression and emergency services to the city.
City of Ames Fleet Services Department	Maintains and repairs city's fleet.
City of Ames CyRide	A city bus system operating fixed routes, a dial-a-ride service for persons with a disability, and a late night service called Moonlight Express. CyRide also provides shuttle services between the city and the Des Moines International Airport.

Table 3-1. (Continued)

Stakeholder	Description
City of Ames Public Works Department	A city department responsible for managing infrastructures within the city. The department includes five divisions: Administration, Traffic, Operations, Engineering, and Resource Recover Plant. Operations Division repairs and maintains city streets, including snow removal and ice control, and also maintains municipal airport. Traffic Division manages signal systems, signs and pavement markings in Ames excluding US 69 and areas under the jurisdiction of the Iowa State University. It also maintains parking system including parking meters, parking lots and regulation signs and markings.
Ames Municipal Airport	A general aviation airport that serves the area.
Nevada Fire Department	Provides fire protection, emergency medical services (EMS), multiple forms of rescue, and Hazmat response for the City of Nevada and the four surrounding townships including Grant, Milford, Richland, and Nevada.
Westory Fire Agency	Provides fire prevention and suppression and emergency services to City of Kelly, City of Gilbert, and two townships including Washington and Franklin.
Story County Engineers Office	Provides construction and maintenance services, including snow removal, on county roads and bridges.
Story County Sheriff's Office	County law enforcement and emergency response. The office has a communications center to respond to 911 emergency calls in the county.
Story County Emergency Management	County emergency management agency promoting emergency preparedness, assisting with the coordination of disaster response and recovery operations, and encouraging mitigation efforts before, during and after a disaster or major emergency.
Boone County Engineer Office	Provides construction and maintenance services, including snow removal, on county roads and bridges.
Boone County Sheriff's Office	County law enforcement and emergency response. The office has a communications center to respond to 911 emergency calls in the county.
Boone County Emergency Management	County emergency management agency promoting emergency preparedness, assisting with the coordination of disaster response and recovery operations, and encouraging mitigation efforts before, during and after a disaster or major emergency.
Boone County Transportation	Contracted with Heart of Iowa Regional Transit Agency (HIRTA, a regional transit authority) to provide public transit services for Boone County.
Heartland Senior Services	Contracted with Heart of Iowa Regional Transit Agency (HIRTA, a regional transit authority) to provide public transit services for Story County, and also contracted with city of Ames to operate dial-a-ride services during weekday, evening and weekend hours within the Ames city limits.
Iowa State University Police	Law enforcement authority for the university. The police division has a communications center to respond to 911 emergency calls in the university.

Table 3-1. (Continued)

Stakeholder	Description
Iowa State University Facilities Services	Provides services to maintain and repair university facilities, including campus street maintenance, winter snow removal, and department vehicle and equipment maintenance.
Mary Greeley Medical Center	A health care provider. The center provides emergency medical dispatch for EMS providers within the City.
Union Pacific Railroad	Operates railroads and associated facilities within the region.
Media Outlets	TV and radio stations, news media, etc.
Special Event Promoters	Special Event Sponsors that have knowledge of events that may impact travel on roadways or other modal means. Examples of special event sponsors include sporting events, conventions, motorcades/parades, and public/political events.
Private Trucking Companies	A stakeholder group representing trucking companies that operate commercial vehicles.
National Weather Service	Provides weather forecast and issues warnings related to adverse weather conditions.

3.2 Operational Concept

An operational concept defines each stakeholder’s current and future roles and responsibilities in the implementation and operation of the regional ITS systems. Table 3-2 summarizes the general roles and responsibilities of the participating stakeholders identified above. As illustrated, the roles and responsibilities are categorized in nine transportation service areas. These transportation service areas provide general classifications of what functions the participating agencies are providing or will provide. The nine service areas and their major functions are described in the following.

Archived Data Management – Archived data management represents the functions that collect, process, store and utilize transportation data including traffic data, accident data, maintenance and construction data, public transportation data, commercial vehicle data, emission data, parking data and others.

Commercial Vehicle Operations – Commercial vehicle operations represents the administrative functions that support commercial vehicle credentials, tax, and safety regulations.

Emergency Management – Emergency management represents the functions that provide emergency call taking, public safety dispatch, disaster response and evacuation, securing monitoring and other security and public safety-oriented services.

Incident Management – Incident management represents the functions that manage both unexpected incidents and planned events so that the impact to the transportation network and traveler safety is minimized. It includes incident detection and verification, appropriate incident response, and regional coordination between traffic management agencies, maintenance and construction management agencies, emergency management agencies and others.

Maintenance and Construction Management – Maintenance and construction management represents the functions that provide construction management and maintenance of roadways, including snow and ice removal.

Public Transportation – Public transportation represents the functions that plan, manage, operate and maintain transit services. It also includes the function that provides transit traveler information.

Traffic Management – Traffic management represents the functions that manage a broad range of transportation facilities including freeway systems, rural and suburban highway systems, and urban and suburban traffic control systems. In the context of this project, it primarily includes network surveillance, traffic signal control, traffic information dissemination, and highway-rail intersection management.

Traveler Information – Traveler information represents the functions that collect, process, store, and disseminate static and real time transportation information to the traveling public.

Transportation Planning and Architecture Maintenance – Transportation planning and ITS architecture maintenance represents transportation planning functions and other related services. It also includes roles and responsibilities for the development and maintenance of an ITS architecture within the stakeholder’s jurisdiction boundary.

Table 3-2. Operational Concept for AAMPO Regional ITS Architecture

Stakeholder	Transportation Service	Roles/Responsibilities	Status
Iowa Department of Transportation	Archived Data Management	Manage DOT databases for Condition Acquisition and Reporting System (CARS), road weather information system (RWIS), automated weather observing stations (AWOS), Decision Support Environment System/Coordinated Transportation Analysis and Management System (CTAMS), State’s crash report data (including data from TraCS system), commercial vehicle credential and safety data, District data, etc.	Existing
	Commercial Vehicle Operations	Administer and enforce federal and state motor vehicle laws and regulations.	Existing
		Administer credential and safety information of carriers, drivers and vehicles.	Existing
		Provide electronic permit applications and reporting, electronic commercial vehicle inspection system, and commercial vehicle operation and management information via Internet.	Existing

Table 3-2. (Continued)

Stakeholder	Transportation Service	Roles/Responsibilities	Status
Iowa Department of Transportation	Commercial Vehicle Operations	Operate Weigh-in-Motion scales and other roadside inspection equipment for law and regulations enforcement.	Existing
		Coordinate commercial vehicle inspection with the Iowa State Patrol and local law enforcement agencies.	Existing
		Use TraCS system to speed safety inspection data processing and communication with other state, county and city agencies.	Existing
	Emergency Management	Participate in coordinated emergency response with local emergency management, public safety, and/or transportation agencies.	Existing
		Support disaster response and recovery, and disaster evacuation.	Existing
		Provide disaster-related traveler information to the public.	Existing
		Operate permanent dynamic message signs (DMSs) for AMBER Alerts.	<i>Planned</i>
	Incident Management	Provide incident information to local incident response agencies including emergency management, public safety, and/or transportation.	Existing
		Coordinate incident response, road closures and detours with local incident response agencies.	Existing
		Provide resources to support incident management when requested by local incident response agencies	Existing
		Operate portable DMS and planned permanent DMS for incident management.	Existing
	Maintenance and Construction Management	Provide construction management and perform maintenance of interstate, state highways and bridges.	Existing
		Dispatch maintenance vehicles for planned activities (road maintenance, snow plowing, etc.) and unplanned incidents within the jurisdiction area.	Existing
		Communicate maintenance and construction schedule and other related information with local agencies.	Existing
		Operate and maintain agency vehicle fleet.	Existing
		Operate portable DMS and planned permanent DMS for maintenance and construction activities.	Existing
		Maintain DOT roadside equipment.	Existing
		Operate RWIS system and collect road weather information along major roadways, and distribute road weather information to local agencies.	Existing

Table 3-2. (Continued)

Stakeholder	Transportation Service	Roles/Responsibilities	Status
Iowa Department of Transportation	Traffic Management	Communicate traffic related information to other agencies.	Existing
		Operate portable DMS and planned permanent DMS to disseminate traffic information.	Existing
		Operate speed detectors to collect traffic speed data.	<i>Planned</i>
		Operate CCTV cameras to provide roadway images.	<i>Planned</i>
	Traveler Information	Provide telephone traveler information (511 System) via either cell phone or landline.	Existing
		Provide traffic conditions, road weather, incidents, road restrictions, roadway work, alerts, and other transportation-related information via Internet. The websites include www.511ia.org and www.weatherview.dot.state.ia.us .	Existing
Iowa State Patrol	Commercial Vehicle Operations	Routinely patrol major roadways including interstates, US highways, state highways and secondary county roads.	Existing
		Participate in roadside vehicle inspection for law and regulations enforcement.	Existing
		Exchange safety and/or security information with other agencies.	Existing
	Emergency Management	Operate the Des Moines Communication Center to provide emergency call taking (911) and dispatch state patrol vehicles on the jurisdiction roadways.	Existing
		Coordinate emergency response with local emergency management, public safety, and/or transportation agencies.	Existing
		Responsible for issuing AMBER Alerts.	Existing
		Operate security monitoring system to monitor public travel-related areas for potential threats and detect potential and actual disasters.	Existing
	Incident Management	Receive emergency calls for incidents within the jurisdiction area and dispatch state patrol vehicles responding to emergency calls.	Existing
		Coordinate incident response with local emergency management, public safety, and/or transportation agencies.	Existing
		Use TraCS system for accident reporting.	Existing
		Share operation responsibility of permanent DMS for incident management.	<i>Planned</i>
	Traveler Information	Observe and collect road conditions on Interstates, US highways, and major state highways. Input road condition information into CARS.	Existing

Table 3-2. (Continued)

Stakeholder	Transportation Service	Roles/Responsibilities	Status
Ames Area Metropolitan Planning Organization	Transportation Planning and ITS Architecture Maintenance	Provide transportation (including ITS) planning and technical assistance services to various agencies within the region.	Existing
		Coordinate regional stakeholders for developing and implementing the Regional ITS Architecture and ITS project.	Existing
		Responsible for the maintenance of the Regional ITS Architecture.	Existing
City of Ames Public Works Department	Archived Data Management	Collect and archive traffic data, accident data, and maintenance data.	Existing
		Collect and archive environmental data collected from RWIS.	<i>Planned</i>
	Emergency Management	Coordinate emergency response with local emergency management, public safety, and/or transportation agencies.	Existing
		Provide resources when requested by emergency response agencies.	Existing
	Incident Management	Perform incident verification on city streets.	Existing
		Provide incident information to local public safety agencies.	Existing
		Coordinate incident response and road closures with local emergency management, public safety, and/or transportation agencies.	Existing
		Provide resources when requested by incident response agencies	Existing
		Operate portable DMS for incident management.	Existing
	Maintenance and Construction Management	Manage maintenance and construction activities on city roads.	Existing
		Dispatch maintenance vehicles for planned activities (road maintenance, snow plowing, etc.) and unplanned incidents within the jurisdictions.	Existing
		Communicate maintenance and construction schedule and information to local agencies.	Existing
		Operate portable DMS for maintenance and construction activities.	Existing
		Maintain city roadside equipment.	Existing
		Operate an automated vehicle location (AVL) system to track maintenance vehicle locations.	<i>Planned</i>
		Operate RWIS system to collect road weather information on city roads.	<i>Planned</i>
	Operate roadway an automated roadway anti-icing system.	<i>Planned</i>	

Table 3-2. (Continued)

Stakeholder	Transportation Service	Roles/Responsibilities	Status
City of Ames Public Works Department	Traffic Management	Operate traffic signal systems within the jurisdiction area.	Existing
		Operate DMS, CCTV, and loop detector stations.	Existing
		Operate Railroad Crossing Automated Horn Warning System.	Existing
		Communicate traffic related information to other agencies	Existing
	Traveler Information	Provides traffic, maintenance and construction information on city roads to the public via an Internet website.	Existing
City of Ames CyRide	Archived Data Management	Collect and archive transit data.	<i>Planned</i>
	Public Transportation	Dispatch fixed-route services to the Ames urbanized area.	Existing
		Operate security cameras on buses to monitor on-board vehicle safety and security.	Existing
		Provide maintenance on agency vehicle fleet.	Existing
		Operate RouteMatch Software to support scheduling, dispatch operations, billing and report.	<i>Planned</i>
		Operate an AVL system to track vehicle locations.	<i>Planned</i>
		Provide real-time transit information to the public via the Internet and an electronic displays/audio announcement system.	<i>Planned</i>
		Operate a Transit Signal Priority system.	<i>Planned</i>
	Incident Management	Report incident information to local public safety agencies.	Existing
City of Ames Police Department	Emergency Management	Respond to emergency dispatches.	Existing
		Coordinate emergency response with local emergency management, public safety, and/or transportation agencies.	Existing
		Support disaster response and recovery, and disaster evacuation.	Existing
		Provide disaster-related information to the public.	Existing
	Incident Management	Respond to incident dispatch	Existing
		Coordinate incident response with local emergency management, public safety and/or transportation agencies.	Existing
		Use TraCS system for accident reporting.	Existing
		Operate permanent DMS for incident management.	<i>Planned</i>

Table 3-2. (Continued)

Stakeholder	Transportation Service	Roles/Responsibilities	Status
City of Ames Fire Department	Emergency Management	Respond to emergency dispatches.	Existing
		Coordinate emergency response with local emergency management, public safety, and/or transportation agencies.	Existing
	Incident Management	Respond to incident dispatch	Existing
		Coordinate incident response with local emergency management, public safety and/or transportation agencies.	Existing
City of Ames Fleet Services Department	Archived Data Management	Collect and manage fleet records.	Existing
	Maintenance and Construction Management	Perform maintenance on city vehicle fleet.	Existing
911 Communications Centers (including Story County Sheriff, City of Ames Police, and Iowa State University Police)	Emergency Management	Provide emergency call taking (911) within the jurisdiction area and dispatch Sheriff, Police, Fire and EMS services.	Existing
		Coordinate emergency response with local emergency management, public safety, and/or transportation agencies.	Existing
	Incident Management	Receive emergency calls for incidents within the jurisdiction and dispatch Sheriff, Police, Fire and EMS services to incidents.	Existing
		Coordinate incident response with local emergency management, public safety and/or transportation agencies.	Existing
		Share operation responsibility of permanent DMS for incident management.	<i>Planned</i>
Story County Engineers Office	Emergency Management	Coordinate emergency response with local emergency management, public safety, and/or transportation agencies.	Existing
		Provide resources when requested by emergency response agencies.	Existing
	Incident Management	Coordinate incident response with local emergency management, law enforcement, and/or transportation agencies.	Existing
		Provide resources when requested by incident response agencies.	Existing

Table 3-2. (Continued)

Stakeholder	Transportation Service	Roles/Responsibilities	Status
Story County Engineers Office	Maintenance and Construction Management	Provide construction management of county roads.	Existing
		Dispatch maintenance vehicles for planned activities (road maintenance, snow plowing, etc.) and unplanned incidents within the jurisdiction area.	Existing
		Maintain agency vehicle fleet.	Existing
		Communicate maintenance and construction schedule and information to local agencies.	Existing
	Traffic Management	Communicate traffic related information to other agencies	Existing
Story County Sheriff's Office	Commercial Vehicle Operations	Participate in roadside vehicle inspection for law and regulations enforcement.	Existing
		Exchange safety and/or security information with other agencies.	Existing
	Emergency Management	Respond to emergency dispatches.	Existing
		Coordinate emergency response with local emergency management, public safety, and/or transportation agencies.	Existing
		Support disaster response and recovery, and disaster evacuation.	Existing
		Provide disaster-related traveler information to the public.	Existing
	Incident Management	Respond to incident dispatches.	Existing
		Coordinate incident response with local emergency management, public safety and/or transportation agencies.	Existing
		Use TraCS system for accident reporting.	Existing
		Operate permanent DMS for incident management.	<i>Planned</i>
Story County Emergency Management	Emergency Management	Develop countywide emergency preparedness plans.	Existing
		Coordinate countywide disaster response and recovery operations.	Existing
	Incident Management	Coordinate incident response with local public safety and/or transportation agencies.	Existing
Boone County Engineer Office	Emergency Management	Coordinate emergency response with local emergency management, public safety, and/or transportation agencies.	Existing
		Provide resources when requested by emergency response agencies.	Existing
	Incident Management	Coordinate incident response with local emergency management, law enforcement, and/or transportation agencies.	Existing
		Provide resources when requested by incident response agencies.	Existing

Table 3-2. (Continued)

Stakeholder	Transportation Service	Roles/Responsibilities	Status
Boone County Engineer Office	Maintenance and Construction Management	Provide construction management of county roads.	Existing
		Dispatch maintenance vehicles for planned activities (road maintenance, snow plowing, etc.) and unplanned incidents within the jurisdiction area.	Existing
		Maintain agency vehicle fleet.	Existing
		Communicate maintenance and construction schedule and information to local agencies.	Existing
	Traffic Management	Communicate traffic related information to other agencies	Existing
Boone County Sheriff's Office	Commercial Vehicle Operations	Participate in roadside vehicle inspection for law and regulations enforcement.	Existing
		Exchange safety and/or security information with other agencies.	Existing
	Emergency Management	Respond to emergency dispatches.	Existing
		Coordinate emergency response with local emergency management, public safety, and/or transportation agencies.	Existing
		Support disaster response and recovery, and disaster evacuation.	Existing
		Provide disaster-related traveler information to the public.	Existing
	Incident Management	Respond to incident dispatches.	Existing
		Coordinate incident response with local emergency management, public safety and/or transportation agencies.	Existing
		Use TraCS system for accident reporting.	Existing
Boone County Emergency Management	Emergency Management	Develop countywide emergency preparedness plans.	Existing
		Coordinate countywide disaster response and recovery operations.	Existing
	Incident Management	Coordinate incident response with local public safety and/or transportation agencies.	Existing
Iowa State University Police	Emergency Management	Respond to emergency dispatches.	Existing
		Coordinate emergency response with local emergency management, public safety, and/or transportation agencies.	Existing
	Incident Management	Respond to incident dispatch	Existing
		Coordinate incident response with local emergency management, public safety, and/or transportation agencies.	Existing
		Use TraCS system for accident reporting.	Existing
Heartland Senior Services	Public Transportation	Provide demand-responsive transit services in Story County and City of Ames.	Existing

Table 3-2. (Continued)

Stakeholder	Transportation Service	Roles/Responsibilities	Status
Mary Greeley Medical Center	Emergency Management	Dispatch ambulances to respond to emergencies.	Existing
		Coordinate emergency response with local emergency management, public safety, and/or transportation agencies.	Existing
		Support disaster evacuation.	Existing
	Incident Management	Dispatch ambulances to respond to incidents	Existing
		Coordinate incident response with local emergency management, public safety, and/or transportation agencies.	Existing
Union Pacific Railroad	Traffic Management	Operate and maintain rail roadside equipment, including equipment that communicates with traffic signals or other traffic control devices at highway rail intersections.	Existing

4. INVENTORY

The AAMPO Regional ITS Architecture inventory identifies all ITS systems that are being implemented or planned throughout the region. Table 4-1 provides a list of ITS systems, their general descriptions, and stakeholders that are involved with or responsible for operations and management of the systems. This inventory is developed based on the following sources:

- AAMPO Regional ITS Architecture Stakeholder Survey and follow-up telephone interviews
- City of Ames Long Range Transportation Plan (source: www.hws-con.com/aampo)
- City of Ames 2005 – 2010 Capital Improvements Plan (source: www.city.ames.ia.us)
- Iowa Statewide ITS Plans for Year 2005 and 2006 (source: Iowa DOT)
- Iowa Statewide ITS Architecture - Draft (source: Iowa DOT)
- Other relevant project reports and websites

The stakeholder survey questionnaire is included in Appendix A.

Table 4-1. AAMPO Regional ITS Inventory

Stakeholder	System	Description	Status	Transportation Service
Iowa DOT	511 Traveler Information System	The 511 traveler information system provides real time travel information to travelers via cell phone and landline calls. Travel information includes traffic conditions, incidents, road restrictions, roadway work, alerts, and other transportation-related information.	Existing	Traveler Information
	511 Travel Information Website	The 511 Travel Information Website (www.511ia.org) provides real time travel information including traffic conditions, incidents, road restrictions, roadway work, alerts, and other transportation-related information. A linkage is connected to the Des Moines TripGuide webpage that shows real-time traffic flow speeds and camera images on I-35, I-80, I-235, US 65, US 69 and Iowa 5 within Des Moines metro area. A link for roadway conditions (www.iowaroadconditions.org) is also available.	Existing	Traveler Information
	WeatherView Website	The WeatherView website (www.weatherview.dot.state.ia.us) provides real-time road weather information to travelers using the data from RWIS and AWOS. The website also provides links to other weather sources. WeatherView is planned to be updated to accommodate new information sources and new forecast formats, such as road cameras information.	Existing	Traveler Information
	Special Event Traffic Study	Special event traffic studies and ITS deployment for recurring special events at Iowa State University. The project includes traffic data collection, preliminary engineering, planning, coordination, archival and deployment of ITS devices. Signal timing, parking restrictions, reverse flow, use of shoulders, etc will also be considered. ITS field devices maybe required to assist with event traffic management.	Planned	
	Portable Dynamic Message	Used to direct traffic for the management of incidents, maintenance and construction, and special events.	Existing	Traffic Management

Stakeholder	System	Description	Status	Transportation Service
	Road Weather Information System (RWIS)	An RWIS station is deployed at I-35 near the City of Ames to monitor road weather conditions, including pavement surface temperature, air temperature, wind speeds and direction, humidity, etc. The central processing servers that receive RWIS data are located in Ames.	Existing	Maintenance and Construction Management/ Archived Data Management
	CARS	The CARS system collects traveler information including road construction, traffic, road weather, accidents, and special events. The information is input via the internet site by authorized personnel including Iowa State Patrol and Iowa DOT Maintenance and Construction.	Existing	Traveler Information/ Archived Data Management
	District Database	Collect and store traffic data and/or maintenance data. The database can perform quality checks on the incoming data and error notification, and support general query and report functionality.	Existing	Archived Data Management
	Weigh-In-Motion (WIM) Scales	WIM devices at weigh stations measure truck weights and axle configuration for enforcing law and regulations. Two WIM scales are located on I-35 south of Ames.	Existing	Commercial Vehicle Operations
	Motor Vehicle Division	Administer credential and safety information of carriers, drivers and vehicles. The MVD website provides commercial vehicle operation and management information, as well as electronic permit applications and reporting, such as automated oversize/over weight permit applications, title applications, and fuel tax reporting. The website also has an Electronic Commercial Vehicle Inspection System that allows carriers to certify via the Internet that all violations noted on an inspection report have been corrected.	Existing	Commercial Vehicle Operations/ Archived Data Management
	Radiation Detection Equipment	Radiation detection equipment for inspection heavy trucks on radiation and explosive. Equipment includes radiation detectors/monitors permanently mounted on patrol vehicles, mini portable Radica monitors worn by officers as part of their uniform, and MCB2 hand held monitors monitoring radiation levels from a distance that the portables will not pick up.	Existing	Commercial Vehicle Operations

Stakeholder	System	Description	Status	Transportation Service
	TraCS	TraCS is a customizable data collection system that can be used by law enforcement and motor vehicle agencies. TraCS includes application software combined with mobile laptop computers, imager/bar code scanners, mobile printers, host workstations, and statewide data communications. TraCS provides electronic incident reports including Crash Reporting, Motor Carrier Inspection Reporting, etc. The report data are shared via Iowa's statewide public law enforcement communications network, and are also stored in Iowa DOT state's crash report database. Participated agencies include Iowa DOT, Iowa State Patrol, Sheriff's offices (55), Police departments (156), and other federal and state agencies.	Existing	Archived Data Management/ Incident Management/ Commercial Vehicle Operations
	District 1 Operations Office	Operate Iowa DOT roadside equipment in District 1 for traffic control and management, and communicate traffic related information to other agencies.	Existing	Traffic Management
	Permanent DMS	A permanent DMS is planned on I-35 south of US 30 for northbound traffic. The DMS will be used to direct traffic for the management of incidents, construction and maintenance, special events, and amber alerts.	Planned	Traffic Management
	Speed Detectors	Speed detectors are planned to be installed near or on the existing RWIS site to collect traffic speed data. Speed information can be used to assess winter maintenance performance and the effects of certain weather events on traffic flow; and monitor the current traffic flow for the traveling public.	Planned	Traffic Management
	CCTV Camera	One camera will be installed on the existing RWIS tower. The camera can provide images of the roadway that can be used by maintenance managers and the traveling public to observe the condition of the road and traffic flow. WeatherView will be upgraded to include camera information.	Planned	Traffic Management
	Ames Maintenance Garage	Dispatch maintenance vehicles for planned activities (road maintenance, snow plowing, etc.) and unplanned incidents within the jurisdiction area, and communicate maintenance and construction schedule and information to other agencies.	Existing	Maintenance and Construction Management

Stakeholder	System	Description	Status	Transportation Service
	Ames Maintenance Garage Maintenance and Construction Vehicle/Equipment	A collection of maintenance vehicles that are utilized to support road maintenance, such as Salt/Sand trucks and Road Repair trucks.	Existing	Maintenance and Construction Management
	Precipitation and Visibility Sensors	Upgrade existing RWIS sensors to optical weather identifiers and visibility detectors or other accurate, versatile precipitation identification equipment. Improved precipitation observations will help maintenance managers and forecasters track the path and characteristics of precipitation. Visibility detection performance will be tested to determine if the observations can be used as a guide for road closures.	Planned	Maintenance and Construction Management
Iowa State Patrol	State Patrol Des Moines 911 Communications Center	Receive 911 calls and calls to the Iowa State Patrol Help Line, and utilize a computer-aided dispatch (CAD) system to dispatch state patrol emergency vehicles.	Existing	Incident Management/ Emergency Management
	State Patrol Emergency Vehicles	Emergency vehicles responding to dispatch, some equipped with laptop computers and TraCS software to speed up crash investigation process.	Existing	Incident Management/ Emergency Management
	Security Monitoring System	Roadside surveillance equipment to monitor public travel-related areas for potential threats and detect potential and actual disasters including natural and man-made disasters.	Existing	Emergency Management
City of Ames Public Works Department	City of Ames Public Works	Manage and control CCTV, DMS, detection sensors, and other roadside equipment within the jurisdiction area for traffic control and management. Communicate traffic related information to other agencies. Dispatch vehicles for maintenance and construction activities, including snow removal and ice control.	Existing	Traffic Engineering/ Maintenance and Construction Management
	Traffic Signal Systems	Traffic signal systems including loop detectors, video detection, and other signal operation equipment used for the control and management of traffic at intersections. Signal systems may be interconnected and/or coordinated with each other. Emergency vehicle signal preemption is provided. Transit signal priority is planned.	Existing	Traffic Management

Stakeholder	System	Description	Status	Transportation Service
	Portable Dynamic Message Signs	Portable DMS can be used to direct traffic for the management of incidents, construction and maintenance, and special events.	Existing	Traffic Management
	Loop Detector Stations	Loop detectors for collecting traffic flow data, such as volume, speed, etc.	Existing	Traffic Management
	CCTV Cameras	CCTV cameras to monitor roadway and/or intersections to support traffic management and emergency/incident management.	Existing	Traffic Management
	Railroad Crossing Automated Horn Warning System	The automated horn system provides audible warnings to motorists and pedestrians by using two stationary horns mounted at the crossing. Each horn directs its sound toward the approaching roadway. The horn system is activated using the same track signal circuitry as the gate arms and bells located at the crossing.	Existing	Traffic Management
	Internet Website	Website to disseminate construction updates to the public. The website also provides historical traffic accident information interactively using WebGIS technology. Real time traffic information is planned.	Existing	Traveler Information
	Traffic and Maintenance Database	Collect and store traffic data and/or maintenance data. The database can perform quality checks on the incoming data and error notification, and support general query and report functionality.	Existing	Archived Data Management
	Road Weather Information System (RWIS)	RWIS are planned along major city roadways to monitor road weather conditions, including bridge and pavement surface temperature, air temperature, wind speeds and direction, humidity, etc.	Planned	Maintenance and Construction Management
	Roadway Anti-Icing Systems	The systems use sensors to identify icy conditions, and release liquid chemicals onto roadways/bridges.	Planned	Maintenance and Construction Management
City of Ames CyRide	CyRide Transit Dispatch Center	Dispatch fixed-route services to the City area. The center is equipped with transit operation management software to assist in dispatch and schedule management.	Existing	Public Transportation
	CyRide Transit Vehicles	A collection of transit vehicles responding to transit dispatches.	Existing	Public Transportation

Stakeholder	System	Description	Status	Transportation Service
	Transit Vehicle On-board Security Cameras	Vehicle cameras were installed in buses to help identify passengers whose behaviors are unacceptable while riding. Cameras have been installed in 28 buses and an additional 20 buses will be equipped.	Existing/ Planned	Public Transportation
	Transit Information Website	Website to provide transit information such as transit routes and schedules, transit transfer options, transit fares, etc. Plan to provide real-time transit information and support trip planning.	Existing/ Planned	Public Transportation
	RouteMatch Software	Plan to install RouteMatch software package to support scheduling, dispatch operations, billing and report.	Planned	Public Transportation
	AVL/GPS System	Plan to install AVL technology to track the exact location of buses to improve operation of both Fixed Route and Moonlight Express.	Planned	Public Transportation
	Automated Vehicle Maintenance Scheduling System	Automate vehicle maintenance scheduling based on vehicle and equipment condition and availability schedules.	Planned	Public Transportation
	Bus Stop Electronic Displays/Audio Announcement	Planned to provide real-time transit information via electronic displays/audio announcement equipment at bus stops.	Planned	Public Transportation
	Transit Signal Priority System	Planned to have the capability to receive priority lights at signalized intersections.	Planned	Public Transportation
	Transit Database	Planned to collect and store transit data. The database would perform quality checks on the incoming data and error notification, and support general query and report functionality.	Planned	Archived Data Management
City of Ames Police Department	City Police 911 Communications Center	Receive 911 calls and dispatch police, fire and EMS within the jurisdiction area using a CAD system.	Existing	Incident Management/ Emergency Management
	City Police Emergency Vehicles	A collection of emergency vehicles responding to emergency/incident dispatches. Some vehicles are equipped with TraCS system for in-car transactions including accident reporting and citations, and emergency preemption light.	Existing	Incident Management/ Emergency Management

Stakeholder	System	Description	Status	Transportation Service
	Computer Aided Dispatch Hardware Update	The updated hardware supports operations of the emergency communications center by providing a record of incidents, location history, property information and the status of all emergency units in the field. When Consolidated 911 CAD Dispatch between three 911 communications centers (Story County, City of Ames and Iowa State University) is completed, the records would be combined with those of Story County Sheriff and Iowa State University Police and be shared with each other.	Planned	Incident Management/ Emergency Management
City of Ames Fire Department	City Fire Emergency Vehicles	Emergency vehicles (fire trucks) responding to emergency/incident dispatches from the Ames Police Communications Center.	Existing	Incident Management/ Emergency management
City of Ames Fleet Services Department	Automated Vehicle Maintenance Scheduling System	Automate vehicle maintenance scheduling based on vehicle and equipment condition and availability schedules.	Existing	Maintenance and Construction Management
	City Maintenance and Construction Vehicles	A collection of maintenance vehicles that are utilized to support road maintenance, such as snow plow trucks, salt/sand trucks, and road repair trucks. Vehicles support communications with the center to receive information and instructions that are provided to vehicle operators. AVL system is planned.	Existing	Maintenance and Construction Management
	Fleet Database	Manage fleet records. The database can perform quality checks on the incoming data and error notification, and support general query and report functionality.	Existing	Archived Data Management

Stakeholder	System	Description	Status	Transportation Service
Story County Sheriff, City of Ames Police and Iowa State University Police	Consolidated 911 Computer Aided Dispatch	<p>Consolidate emergency communications activities between three 911 communications centers in the area (Story County, City of Ames, and Iowa State University). Three phases/components are proposed:</p> <ul style="list-style-type: none"> • Shared CAD and Data Network: allowing three communications centers to seamlessly access each other's record information. • Mapping System: installing telephone switch hardware to accept location information from cellular calls, and installing software modules to display incidents and calls on the city/county map in the consolidated CAD and Crime Records systems. • Mobile Data Terminals for Emergency Vehicles: providing field access to sheriff/police records, state and federal databases and direct connections to CAD information for emergency vehicles. The system will be built on the current "core technologies" in the communications centers and the TraCS system currently operating in the patrol vehicles. 	Planned	Incident Management/ Emergency Management
Story County Engineers	County Maintenance and Construction Vehicles Dispatch Center	Dispatch vehicles for maintenance and construction activities, including snow removal and ice control.	Existing	Maintenance and Construction Management
	County Maintenance and Construction Vehicles	A collection of maintenance vehicles that are utilized to support road maintenance, such as snow plow trucks, salt/sand trucks, and road repair trucks. Vehicles support communications with the center to receive information and instructions that are provided to vehicle operators.	Existing	Maintenance and Construction Management
	Automated Maintenance Scheduling System for Maintenance and Construction Vehicles	Automated vehicle maintenance scheduling based on vehicle and equipment condition and availability schedules.	Planned	Maintenance and Construction Management

Stakeholder	System	Description	Status	Transportation Service
Story County Sheriff	County Sheriff 911 Communications Center	Receive 911 calls, and dispatch police, fire and EMS within the county jurisdiction. CAD dispatch is equipped.	Existing	Incident Management/ Emergency Management
	County Sheriff Emergency Vehicles	A collection of emergency vehicles responding to emergency/incident dispatches. Some vehicles are equipped with TraCS system for in-car transactions including accident reporting and citations.	Existing	Incident Management/ Emergency Management
Iowa State University Police	University Police 911 Communications Center	Receive 911 calls originated from university campus, and dispatch local emergency response units including campus police officers, the fire department, and ambulance services. The center is equipped with a CAD system.	Existing	Incident Management/ Emergency Management
	University Police Emergency Vehicles	A collection of emergency vehicles responding to emergency/incident dispatches. Some vehicles are equipped with TraCS system for in-car transactions including accident reporting and citations.	Existing	Incident Management/ Emergency Management
Heartland Senior Services	Heartland Senior Services Dispatch Center	Dispatch demand-responsive transit services to Story County and City of Ames. RouteMatch software is installed to support scheduling, dispatch operations, billing and report.	Existing	Public Transportation
	Heartland Senior Services Transit Vehicles	A collection of transit vehicles responding to transit dispatches.	Existing	Public Transportation
Mary Greeley Medical Center	Emergency Medical Dispatch Center	Dispatch ambulances for EMS providers within the City of Ames. CAD dispatch is planned.	Existing	Incident Management/ Emergency Management
	Ambulances	Equipped with preemption lights for emergency vehicle preemption at signalized intersections.	Existing	Incident Management/ Emergency Management
Nevada Fire Department	Fire Department Emergency Vehicles	A collection of emergency vehicles responding to emergency/incident dispatches from the Story County Sheriff Communications Center.	Existing	Incident Management/ Emergency Management

Stakeholder	System	Description	Status	Transportation Service
Westory Fire Agency	Fire Department Emergency Vehicles	A collection of emergency vehicles responding to emergency/incident dispatches from the Story County Sheriff Communications Center.	Existing	Incident Management/ Emergency Management
Union Pacific Railroad	Railroad Crossing Equipment	Train interface equipment located at or near railroad crossings. This equipment is operated and maintained by the railroad company.	Existing	Traffic Management
Media Outlets	Media	Provide traffic reports, travel conditions, incident and special event, and other transportation-related news services to the traveling public through radio, TV, and other media outlets.	Existing	Traveler Information
Private Trucking Companies	Commercial Vehicles	Commercial vehicles equipped with the sensory, processing, storage, and communications functions necessary to support safe and efficient commercial vehicle operations.	Existing	Commercial Vehicle Operations
Special Event Promoters	Event Promoters	Special events include sporting events, conventions, motorcades/parades, and public/political events. These promoters interface to the ITS to provide event information such as date, time, estimated duration, location, and any other information pertinent to traffic movement in the surrounding area.	Existing	Incident Management

5. MARKET PACKAGES

5.1 Identification of Market Packages

Market packages provide an accessible, deployment oriented perspective to the National ITS Architecture. They are tailored to fit—separately or in combination—real world transportation problems and needs. Market packages enable transportation planners and decision makers to determine appropriate ITS services that satisfy local needs. Market packages collect together one or more equipment packages that must work together to deliver a given transportation service and the architecture flows that connect them and other important external systems. In other words, they identify the pieces of the Physical Architecture that are required to implement a particular transportation service. Because they were evaluated during the architecture development, supporting benefits and costs analyses are also available for market packages.

A list of eighty-five “generic” market packages is provided in the National ITS Architecture (Version 5.1). All eighty-five market packages were examined with regard to their applicability to the region’s ITS inventory. The AAMPO ITS inventory was mapped against the candidate market packages as illustrated in Table 5-1.

Table 5-2 presents a list of market packages that are identified through the mapping process in Table 5-1. The market packages are grouped according to the type of ITS category they fall under, i.e., Archived Data Management, Advanced Public Transportation Systems, etc. As illustrated in Tables 5-1 and 5-2, some of the market packages are not applicable to the implementation of the existing and proposed ITS systems in the region. Therefore, a customization of the market packages is necessary so that the market packages that are inappropriate for the AAMPO Regional ITS Architecture are eliminated. Descriptions of the market packages can be found via the National ITS Architecture website at <http://itsarch.iteris.com/itsarch/>.

Table 5-1. (Continued)

Market Package E – Indicates existing market packages P – Indicates planned market packages		Stakeholder and Associated ITS Inventory																			
		City of Ames CyRide								City of Ames Police		City of Ames Fleet Services		Story County Engineers			Story County Sheriff				
		CyRide Transit Dispatch	CyRide Transit Vehicles	Transit Vehicle On-board Security Cameras	Transit Information Website	RouteMatch Software	AVL/GPS System	Automated Vehicle Maintenance Scheduling System	Bus Stop Electronic Displays/Audio Announcement System	Transit Signal Priority System	Transit Database	City Police 911 Communications Center	City Police Emergency Vehicles	Automated Vehicle Maintenance Scheduling System	City Maintenance and Construction Vehicles	Fleet Database	County Maintenance and Construction Vehicles Dispatch Center	County Maintenance and Construction Vehicles	Automated Maintenance Scheduling System for Maintenance and Construction Vehicles	County Sheriff 911 Communications Center	County Sheriff Emergency Vehicles
AD	ITS Data Mart	P							P					E							
	ITS Data Warehouse									E											E
	ITS Virtual Data Warehouse																				
APTS	Transit Vehicle Tracking	P	P			P															
	Transit Fixed Route Operations	E	E																		
	Demand Response Transit Operations																				
	Transit Passenger and Fare Management																				
	Transit Security	E	E	E																	
	Transit Maintenance		P				P														
ATIS	Multi-Modal Coordination	P	P					P													
	Transit Traveler Information							P													
	Broadcast Traveler Information					E															
	Interactive Traveler Information					P															
	Autonomous Route Guidance																				
	Dynamic Route Guidance																				
	ISP Based Route Guidance																				
	Integrated Transportation Management/Route Guidance																				
	Yellow Pages and Reservation																				
ATMS	Dynamic Ridesharing																				
	In-Vehicle Signing																				
	Network Surveillance																				
	Probe Surveillance																				
	Surface Street Control																				
	Freeway Control																				
	HOV Lane Management																				
	Traffic Information Dissemination										P									P	
	Regional Traffic Control																				
	Traffic Incident Management System	E									E	E				E			E	E	
	Traffic Forecast and Demand Management																				
	Electronic Toll Collection																				
	Emissions Monitoring and Management																				
	Virtual TMC an Smart Probe Data																				
	Standard Railroad Grade Crossing																				
	Advanced Railroad Grade Crossing																				
	Railroad Operations Coordination																				
Parking Facility Management																					
Regional Parking Management																					
Reversible Lane Management																					
Speed Monitoring																					
Drawbridge Management																					
Roadway Closure Management																					
AVSS	Vehicle Safety Monitoring																				
	Driver Safety Monitoring																				
	Longitudinal Safety Warning																				
	Lateral Safety Warning																				
	Intersection Safety Warning																				
	Pre-Crash Restraint Requirement																				
	Driver Visibility Improvement																				
	Advanced Vehicle Longitudinal Control																				
	Advanced Vehicle Lateral Control																				
	Intersection Collision Avoidance																				
	Automated Highway System																				
	CVO	Fleet Administration																			
Freight Administration																					
Electronic Clearance																					
CV Administrative Processes																				E	
International Border Electronic Clearance																					
Weigh In Motion																					
Roadside CVO Safety																					
On-board CVO and Freight Safety & Security																					
CVO Fleet Maintenance																					
HAZMAT Management																					
Roadside HAZMAT Security Detection and Mitigation																					
EM	CV Driver Security Authentication																				
	Freight Assignment Tracking																				
	Emergency Call-Taking and Dispatch									E	E								E	E	
	Emergency Routing									E	E					E	E				
	Mayday and Alarms Support																				
	Roadway Service Patrols																				
	Transportation Infrastructure Protection																				
	Wide-Area Alert																				
Early Warning System																					
MCO	Disaster Response and Recovery	E								E					E				E		
	Evacuation and Reentry Management	E								E					E				E		
	Disaster Traveler Information									E									E		
	Maintenance and Construction Vehicle and Equipment Tracking													P							
	Maintenance and Construction Vehicle Maintenance													E					P		
	Road Weather Data Collection																				
	Weather Information Processing and Distribution																				
	Roadway Automated Treatment																				
	Winter Maintenance														E	E	E				
Roadway Maintenance and Construction														E	E	E					
Work Zone Management																					
Work Zone Safety Monitoring																					
Maintenance and Construction Activity Coordination																E					

Table 5-1. (Continued)

Market Package E – Indicates existing market packages P – Indicates planned market packages		Stakeholder and Associated ITS Inventory											
		Iowa State University Police		Mary Greeley Medical Center		Heartland Senior Services		Nevada Fire	Westory Fire	Union Pacific Railroad	Media Outlets	Private Trucking Companies	
		University Police 911 Communications Center	University Police Emergency Vehicles	Emergency Medical Dispatch Center	Ambulances	Heartland Senior Services Dispatch Center	Heartland Senior Services Transit Vehicles	Fire Emergency Vehicles	Fire Emergency Vehicles	Railroad Crossing Equipment	Median	Commercial Vehicles	
AD	ITS Data Mart												
	ITS Data Warehouse	E											
	ITS Virtual Data Warehouse												
APTS	Transit Vehicle Tracking												
	Transit Fixed Route Operations												
	Demand Response Transit Operations					E	E						
	Transit Passenger and Fare Management												
	Transit Security												
	Transit Maintenance												
	Multi--Modal Coordination												
	Transit Traveler Information												
ATIS	Broadcast Traveler Information												
	Interactive Traveler Information												
	Autonomous Route Guidance												
	Dynamic Route Guidance												
	ISP Based Route Guidance												
	Integrated Transportation Management/Route Guidance												
	Yellow Pages and Reservation												
	Dynamic Ridesharing												
	In-Vehicle Signing												
	ATMS	Network Surveillance											
Probe Surveillance													
Surface Street Control													
Freeway Control													
HOV Lane Management													
Traffic Information Dissemination													
Regional Traffic Control													
Traffic Incident Management System		E	E	E	E	E		E	E				
Traffic Forecast and Demand Management													
Electronic Toll Collection													
Emissions Monitoring and Management													
Virtual TMC an Smart Probe Data													
Standard Railroad Grade Crossing										E			
Advanced Railroad Grade Crossing													
Railroad Operations Coordination													
Parking Facility Management													
Regional Parking Management													
Reversible Lane Management													
Speed Monitoring													
Drawbridge Management													
Roadway Closure Management													
AVSS	Vehicle Safety Monitoring												
	Driver Safety Monitoring												
	Longitudinal Safety Warning												
	Lateral Safety Warning												
	Intersection Safety Warning												
	Pre-Crash Restraint Requirement												
	Driver Visibility Improvement												
	Advanced Vehicle Longitudinal Control												
	Advanced Vehicle Lateral Control												
	Intersection Collision Avoidance												
	Automated Highway System												
	CVO	Fleet Administration											
		Freight Administration											
Electronic Clearance													
CV Administrative Processes													
International Border Electronic Clearance													
Weigh In Motion												E	
Roadside CVO Safety													
On-board CVO and Freight Safety & Security													
CVO Fleet Maintenance													
HAZMAT Management													
Roadside HAZMAT Security Detection and Mitigation												E	
CV Driver Security Authentication													
Freight Assignment Tracking													
EM	Emergency Call-Taking and Dispatch	E	E	E	E			E	E				
	Emergency Routing				E								
	Mayday and Alarms Support												
	Roadway Service Patrols												
	Transportation Infrastructure Protection												
	Wide-Area Alert												
	Early Warning System												
	Disaster Response and Recovery			E									
Evacuation and Reentry Management													
Disaster Traveler Information													
MCO	Maintenance and Construction Vehicle and Equipment Tracking												
	Maintenance and Construction Vehicle Maintenance												
	Road Weather Data Collection												
	Weather Information Processing and Distribution												
	Roadway Automated Treatment												
	Winter Maintenance												
	Roadway Maintenance and Construction												
	Work Zone Management												
	Work Zone Safety Monitoring												
Maintenance and Construction Activity Coordination													

Table 5-2. List of Market Packages for AAMPO Regional ITS Architecture

Category	Market Package	Market Package Name	Status
Archived Data Management (AD)	AD1	ITS Data Mart	Existing/Planned
	AD2	ITS Data Warehouse	Existing
	AD3	ITS Virtual Data Warehouse	Not Planned
Advanced Public Transportation Systems (APTS)	APTS01	Transit Vehicle Tracking	Planned
	APTS02	Transit Fixed Route Operations	Existing
	APTS03	Demand Response Transit Operations	Existing
	APTS04	Transit Passenger and Fare Management	Not Planned
	APTS05	Transit Security	Existing/Planned
	APTS06	Transit Maintenance	Planned
	APTS07	Multi-Modal Coordination	Planned
	APTS08	Transit Traveler Information	Planned
Advanced Traveler Information Systems (ATIS)	ATIS01	Broadcast Traveler Information	Existing
	ATIS02	Interactive Traveler Information	Existing/Planned
	ATIS03	Autonomous Route Guidance	Not Planned
	ATIS04	Dynamic Route Guidance	Not Planned
	ATIS05	ISP Based Route Guidance	Not Planned
	ATIS06	Integrated Transportation Management/Route Guidance	Not Planned
	ATIS07	Yellow Pages and Reservation	Not Planned
	ATIS08	Dynamic Ridesharing	Not Planned
	ATIS09	In-Vehicle Signing	Not Planned
Advanced Traffic Management Systems (ATMS)	ATMS01	Network Surveillance	Existing/Planned
	ATMS02	Probe Surveillance	Not Planned
	ATMS03	Surface Street Control	Existing
	ATMS04	Freeway Control	Not Planned
	ATMS05	HOV Lane Management	Not Planned
	ATMS06	Traffic Information Dissemination	Existing/Planned
	ATMS07	Regional Traffic Control	Not Planned
	ATMS08	Traffic Incident Management System	Existing
	ATMS09	Traffic Forecast and Demand Management	Not Planned
	ATMS10	Electronic Toll Collection	Not Planned
	ATMS11	Emissions Monitoring and Management	Not Planned
	ATMS12	Virtual TMC and Smart Probe Data	Not Planned
	ATMS13	Standard Railroad Grade Crossing	Existing
	ATMS14	Advanced Railroad Grade Crossing	Not Planned
	ATMS15	Railroad Operations Coordination	Not Planned
	ATMS16	Parking Facility Management	Not Planned
	ATMS17	Regional Parking Management	Not Planned
	ATMS18	Reversible Lane Management	Not Planned
	ATMS19	Speed Monitoring	Not Planned
	ATMS20	Drawbridge Management	Not Planned
	ATMS21	Roadway Closure Management	Not Planned

Category	Market Package	Market Package Name	Status
Vehicle Safety (AVSS)	AVSS01	Vehicle Safety Monitoring	Not Planned
	AVSS02	Driver Safety Monitoring	Not Planned
	AVSS03	Longitudinal Safety Warning	Not Planned
	AVSS04	Lateral Safety Warning	Not Planned
	AVSS05	Intersection Safety Warning	Not Planned
	AVSS06	Pre-Crash Restraint Requirement	Not Planned
	AVSS07	Driver Visibility Improvement	Not Planned
	AVSS08	Advanced Vehicle Longitudinal Control	Not Planned
	AVSS09	Advanced Vehicle Lateral Control	Not Planned
	AVSS10	Intersection Collision Avoidance	Not Planned
	AVSS11	Automated Highway System	Not Planned
Commercial Vehicle Operations (CVO)	CVO01	Fleet Administration	Not Planned
	CVO02	Freight Administration	Not Planned
	CVO03	Electronic Clearance	Not Planned
	CVO04	CV Administrative Processes	Existing
	CVO05	International Border Electronic Clearance	Not Planned
	CVO06	Weigh In Motion	Existing
	CVO07	Roadside CVO Safety	Not Planned
	CVO08	On-Board CVO Safety	Not Planned
	CVO09	CVO Fleet Maintenance	Not Planned
	CVO10	HAZMAT Management	Not Planned
	CVO11	Roadside HAZMAT Security Detection and Mitigation	Existing
	CVO12	CA Driver Security Authentication	Not Planned
	CVO13	Freight Assignment Tracking	Not Planned
Emergency Management (EM)	EM01	Emergency Call-Taking and Dispatch	Existing
	EM02	Emergency Routing	Existing
	EM03	Mayday Support	Not Planned
	EM04	Roadway Service Patrols	Not Planned
	EM05	Transportation Infrastructure Protection	Existing
	EM06	Wide-Area Alert	Existing
	EM07	Early Warning System	Not Planned
	EM08	Disaster Response and Recovery	Existing
	EM09	Evacuation and Reentry Management	Existing
	EM10	Disaster Traveler Information	Existing
Maintenance & Construction Management (MC)	MC01	Maintenance and Construction Vehicle and Equipment Tracking	Planned
	MC02	Maintenance and Construction Vehicle Maintenance	Existing/Planned
	MC03	Road Weather Data Collection	Existing/Planned
	MC04	Weather Information Processing and Distribution	Existing/Planned
	MC05	Roadway Automated Treatment	Planned
	MC06	Winter Maintenance	Existing
	MC07	Roadway Maintenance and Construction	Existing
	MC08	Work Zone Management	Existing
	MC09	Work Zone Safety Monitoring	Not Planned
	MC10	Maintenance and Construction Activity Coordination	Existing

5.2 Customization of Market Packages

Market packages, customized for the specific requirements of each stakeholder, represent the information that will be exchanged between specific stakeholder elements. The above market packages selected for the AAMPO Regional ITS Architecture were customized to correspond with the existing ITS system elements and operations as well as future deployment and planned operations. Customization of market packages requires tailoring the elements (subsystems or terminators) in these market packages, along with associated architecture flows. In addition, architecture flows deemed by the stakeholders as not relevant to the deployment need to be removed. The results of such customization are summarized in terms of ITS elements and their deployment status as presented in Table 5-3. Completed results of the customization are detailed in the Turbo Architecture database.

Table 5-3. List of Market Packages by Architecture Elements

Market Package	Market Package Name	Associated Element	Status
AD1	ITS Data Mart	City of Ames CyRide	Planned
		City of Ames CyRide Transit Database	Planned
		City of Ames Fleet Services	Existing
		City of Ames Fleet Services Database	Existing
		City of Ames Public Works	Existing
		City of Ames Public Works Loop Detector Stations	Existing
		City of Ames Public Works RWIS	Planned
		City of Ames Public Works Traffic and Maintenance Database	Existing
		Iowa DOT Ames Maintenance Garage	Existing
		Iowa DOT District 1 Database	Existing
		Iowa DOT District 1 Operations Office	Existing
		Iowa DOT RWIS Central System	Existing
		Iowa DOT RWIS Stations	Existing
AD2	ITS Data Warehouse	City of Ames Police Communications Center	Existing
		Iowa DOT Ames Maintenance Garage	Existing
		Iowa DOT CARS	Existing
		Iowa DOT TraCS System	Existing
		Iowa State Patrol Des Moines Communications Center	Existing
		Iowa State University Police Communications Center	Existing
		Story County Sheriff Communications Center	Existing
APTS1	Transit Vehicle Tracking	City of Ames CyRide	Planned
		City of Ames CyRide Transit Vehicles	Planned
APTS2	Transit Fixed-Route Operations	City of Ames CyRide	Existing
		City of Ames CyRide Transit Vehicles	Existing
		Transit System Operators	Existing
APTS3	Demand Response Transit Operations	Heartland Senior Services	Existing
		Heartland Senior Services Transit Vehicles	Existing
		Transit System Operators	Existing
APTS5	Transit Security	City of Ames CyRide	Existing
		City of Ames CyRide Transit Vehicles	Existing

Market Package	Market Package Name	Associated Element	Status
APTS6	Transit Maintenance	City of Ames CyRide	Planned
		City of Ames CyRide Transit Vehicles	Planned
		Transit System Operators	Planned
APTS7	Multi-modal Coordination	City of Ames CyRide	Planned
		City of Ames CyRide Transit Vehicles	Planned
		City of Ames Public Works	Planned
		City of Ames Public Works Traffic Signal Systems	Planned
APTS8	Transit Traveler Information	City of Ames CyRide	Planned
		City of Ames CyRide Bus Stop Electronic Display/Audio Announcement	Planned
		City of Ames CyRide Transit Information Website	Planned
ATIS1	Broadcast Traveler Information	City of Ames CyRide Transit Information Website	Existing
		City of Ames Public Works Website	Existing
		Iowa DOT 511 Travel Information Website	Existing
		Iowa DOT WeatherView Website	Existing
		Iowa DOT CARS	Existing
		User Personal Computing Devices	Existing
		National Weather Services	Existing
		Private Weather Service Providers	Existing
ATIS2	Interactive Traveler Information	City of Ames CyRide Transit Information Website	Planned
		City of Ames Public Works Website	Planned
		Iowa DOT 511 Traveler Information System	Existing
		Iowa DOT CARS	Existing
		Telecommunications System for Traveler Information	Existing
		User Personal Computing Devices	Existing
ATMS01	Network Surveillance	City of Ames Public Works	Existing
		City of Ames Public Works CCTV Cameras	Existing
		City of Ames Public Works Loop Detector Stations	Existing
		Iowa DOT Ames Maintenance Garage	Planned
		Iowa DOT CCTV Camera on RWIS Tower	Planned
		Iowa DOT District 1 Operations Office	Planned
		Iowa DOT Speed Detectors near or on RWIS Sites	Planned
ATMS03	Surface Street Control	City of Ames Public Works	Existing
		City of Ames Public Works CCTV Cameras	Existing
		City of Ames Public Works Loop Detector Stations	Existing
		City of Ames Public Works Traffic Signal Systems	Existing
ATMS06	Traffic Information Dissemination	City of Ames Police Communications Center	Planned
		City of Ames Public Works	Existing
		City of Ames Public Works Portable DMS	Existing
		Iowa DOT Ames Maintenance Garage	Existing
		Iowa DOT CARS	Planned
		Iowa DOT District 1 Operations Office	Existing
		Iowa DOT Permanent DMS	Planned
		Iowa DOT Portable DMS	Existing
Iowa State Patrol Des Moines Communications Center	Planned		

Market Package	Market Package Name	Associated Element	Status
		Story County Sheriff Communications Center	Planned
ATMS08	Traffic Incident Management System	City of Ames CyRide	Existing
		City of Ames Police Communications Center	Existing
		City of Ames Police Emergency Vehicles	Existing
		City of Ames Public Works	Existing
		City of Ames Public Works CCTV Cameras	Planned
		Heartland Senior Services	Existing
		Iowa DOT Ames Maintenance Garage	Existing
		Iowa DOT CCTV Cameras on RWIS Tower	Planned
		Iowa DOT District 1 Operations Office	Existing
		Iowa State Patrol Des Moines Communications Center	Existing
		Iowa State Patrol District 1 Emergency Vehicles	Existing
		Iowa State University Police Communications Center	Existing
		Iowa State University Police Emergency Vehicles	Existing
		Mary Greeley Medical Center Ambulances	Existing
		Mary Greeley Medical Center Dispatch	Existing
		Nevada Fire Department Emergency Vehicles	Existing
		Story County Engineers	Existing
		Story County Sheriff Communications Center	Existing
		Story County Sheriff Emergency Vehicles	Existing
		Union Pacific Railroad	Existing
Westory Fire Agency Emergency Vehicles	Existing		
Special Event Promoters	Existing		
ATMS13	Standard Railroad Grade Crossing	City of Ames Public Works	Existing
		City of Ames Public Works Railroad Crossing Automated Horn Warning System	Existing
		City of Ames Public Works Traffic Signal Systems	Existing
		Union Pacific Railroad Wayside Equipment	Existing
CVO04	CV Administrative Processes	Iowa DOT Motor Vehicle Division	Existing
		Iowa State Patrol District 1	Existing
		Story County Sheriff Communications Center	Existing
CVO06	Weigh-In-Motion	Iowa DOT Weigh Stations	Existing
		Private Commercial Vehicles	Existing
CVO11	Roadside HAZMAT Security Detection and Mitigation	Iowa DOT Motor Vehicle Division Radiation Detection Equipment	Existing
		Private Commercial Vehicles	Existing
EM01	Emergency Call-Taking and Dispatch	City of Ames Police Communications Center	Existing
		City of Ames Police Emergency Vehicles	Existing
		Iowa State Patrol Des Moines Communications Center	Existing
		Iowa State Patrol District 1 Emergency Vehicles	Existing
		Iowa State University Police Communications Center	Existing
		Iowa State University Police Emergency Vehicles	Existing
		Mary Greeley Medical Center Dispatch	Existing
		Mary Greeley Medical Center Ambulances	Existing
		Nevada Fire Department Emergency Vehicles	Existing

Market Package	Market Package Name	Associated Element	Status
		Story County Sheriff Communications Center	Existing
		Story County Sheriff Emergency Vehicles	Existing
		Westory Fire Agency Emergency Vehicles	Existing
EM02	Emergency Routing	City of Ames Police Emergency Vehicles	Existing
		City of Ames Public Works Traffic Signal Systems	Existing
		Iowa DOT District 1 Operations Office	Existing
		Iowa State Patrol Des Moines Communications Center	Existing
		Iowa State Patrol District 1 Emergency Vehicles	Existing
		Mary Greely Medical Center Ambulances	Existing
EM05	Transportation Infrastructure Protection	Iowa State Patrol Des Moines Communications Center	Existing
		Iowa State Patrol Security Monitoring Field Equipment	Existing
EM06	Wide-Area Alert	Iowa DOT	Existing
		Iowa DOT 511 Travel Information Website	Existing
		Iowa DOT District 1 Operations Office	Existing
		Iowa DOT Portable DMS	Existing
		Iowa DOT Permanent DMS	Planned
		Iowa State Patrol	Existing
		Iowa State Patrol Des Moines Communications Center	Existing
		User Personal Computing Devices	Existing
EM08	Disaster Response and Recovery	City of Ames CyRide	Existing
		City of Ames Police Communications Center	Existing
		City of Ames Public Works	Existing
		Iowa DOT Ames Maintenance Garage	Existing
		Iowa DOT District 1 Operations Office	Existing
		Iowa State Patrol Des Moines Communications Center	Existing
		Iowa State Patrol District 1	Existing
		Iowa State University Police Communications Center	Existing
		Mary Greenly Medical Center Dispatch	Existing
		Story County Engineers	Existing
		Story County Sheriff Communications Center	Existing
EM09	Evacuation and Reentry Management	City of Ames CyRide	Existing
		City of Ames Police Communications Center	Existing
		Iowa DOT Ames Maintenance Garage	Existing
		Iowa DOT District 1 Operations Office	Existing
		Iowa State University Police Communications Center	Existing
		Story County Sheriff Communications Center	Existing
EM10	Disaster Traveler Information	City of Ames Police Communications Center	Existing
		Iowa DOT 511 Traveler Information Website	Existing
		Iowa DOT 511 Traveler Information System	Existing
		Story County Sheriff Communications Center	Existing
		User Personal Computing Devices	Existing
		Media	Existing
		National Weather Service	Existing
		Telecommunications System for Traveler Information	Existing

Market Package	Market Package Name	Associated Element	Status
MC01	Maintenance and Construction Vehicle and Equipment Tracking	City of Ames Public Works	Planned
		City of Ames Maintenance and Construction Vehicles/Equipment	Planned
		Maintenance and Construction Personnel	Planned
MC02	Maintenance and Construction Vehicle Maintenance	City of Ames Fleet Services	Existing
		Story County Engineers	Planned
		Maintenance and Construction Personnel	Existing
MC03	Road Weather Data Collection	City of Ames Public Works	Planned
		City of Ames Public Works RWIS	Planned
		Iowa DOT Ames Maintenance Garage	Existing
		Iowa DOT RWIS Central System	Existing
		Iowa DOT RWIS Stations	Existing
		Iowa State Patrol Des Moines Communications Center	Existing
		National Weather Service	Existing
		Private Weather Service Providers	Existing
MC04	Weather Information Processing and Distribution	City of Ames Public Works	Planned
		Iowa DOT 511 Travel Information Website	Existing
		Iowa DOT 511 Traveler Information System	Existing
		Iowa DOT Ames Maintenance Garage	Existing
		Iowa DOT RWIS Central System	Existing
		Iowa DOT WeatherView Website	Existing
		National Weather Service	Existing
		Private Weather Service Providers	Existing
MC05	Roadway Automated Treatment	City of Ames Public Works	Planned
		City of Ames Public Works Roadway Anti-Icing System	Planned
		Maintenance and Construction Personnel	Planned
MC06	Winter Maintenance	City of Ames Public Works	Existing
		City of Ames Maintenance and Construction Vehicle/Equipment	Existing
		Iowa DOT Ames Maintenance Garage	Existing
		Iowa DOT Ames Maintenance Garage Maintenance and Construction Vehicles/Equipment	Existing
		Story County Engineers	Existing
		Story County Engineers Maintenance and Construction Vehicles/Equipment	Existing
		National Weather Service	Existing
		Private Weather Service Providers	Existing
MC07	Roadway Maintenance and Construction	City of Ames Public Works	Existing
		City of Ames Maintenance and Construction Vehicle/Equipment	Existing
		Iowa DOT Ames Maintenance Garage	Existing
		Iowa DOT Ames Maintenance Garage Maintenance and Construction Vehicles/Equipment	Existing
		Story County Engineers	Existing
		Story County Engineers Maintenance and Construction Vehicles/Equipment	Existing
		National Weather Service	Existing

Market Package	Market Package Name	Associated Element	Status
		Private Weather Service Providers	Existing
MC08	Work Zone Management	City of Ames Public Works	Existing
		City of Ames Public Works CCTV Cameras	Existing
		City of Ames Public Works Portable DMS	Existing
		Iowa DOT Ames Maintenance Garage	Existing
		Iowa DOT Portable DMS	Existing
		Iowa DOT Permanent DMS	Planned
		Media	Existing
MC10	Maintenance and Construction Activity Coordination	City of Ames CyRide	Existing
		City of Ames Police Communications Center	Existing
		City of Ames Public Works	Existing
		Iowa DOT Ames Maintenance Garage	Existing
		Iowa DOT District 1 Operations Office	Existing
		Iowa State Patrol Des Moines Communications Center	Existing
		Mary Greely Medical Center Dispatch	Existing
		Story County Engineers	Existing
		Story County Sheriff Communications Center	Existing
		Union Pacific Railroad	Existing
		Media	Existing

6. SUBSYSTEMS, EQUIPMENT PACKAGES AND FUNCTIONAL REQUIREMENTS

As one of the required components of an ITS architecture identified in FHWA Final Rule and FTA Policy on ITS Architecture and Standards, this section of the report summarizes the system functional requirements for the AAMPO Regional ITS Architecture in terms of market packages, subsystems, and equipment packages.

6.1 Mapping of Market Packages to Subsystems and Equipment Packages

A market package is implemented with a combination of interrelated equipment; this equipment often resides in several different subsystems within the architecture framework and may be operated by different stakeholders. For instance, the Transit Vehicle Tracking market package includes vehicle location equipment in the Transit Vehicle Subsystem and a base station element in the Transit Management Subsystem. In this example, all market package elements are owned and operated by the same transit stakeholder.

In other cases, the market package elements are owned and operated by different stakeholders. Many of the Advanced Traveler Information Systems (ATIS) market packages require equipment in the Information Service Provider Subsystem that is owned and operated by a public or private information provider and equipment that is acquired and operated by the consumer as part of the Vehicle Subsystem or Personal Information Access Subsystem. Since equipment in different subsystems may be purchased and operated by different end-users, these subsystem-specific components may encounter varied deployment.

To understand and analyze these potential deployment variations, the defined market packages must be decomposed to their constituent elements. The portion of the market package capabilities that are allocated to each subsystem are segregated and defined as equipment packages to support this additional resolution. An equipment package represents a set of equipment/capabilities that are likely to be purchased by an end-user as a component to an overall system. It should be noted that there are no equipment packages defined for the terminators of the National ITS Architecture, as they represent systems on the boundary of the architecture and do not have functional descriptions within the architecture.

Table 6-1 illustrates the subsystems and equipment packages that mapped to the customized list of market packages. The table illustrates the specific market packages in the AAMPO Regional ITS Architecture, the subsystems that are part of the market packages, and the equipment packages that make up the market packages. As indicated in the table, the architecture provides a means to map the market package to appropriate subsystems (components) and equipment packages (technology). The equipment packages identified in Table 6-1 were used to develop the specific functional requirements of each element. The definitions of the equipment packages can be found via the National ITS Architecture website at <http://itsarch.iteris.com/itsarch/>.

Table 6-1. Market Packages, Subsystems and Equipment Packages

Market Package	Market Package Name	Subsystem	Equipment Package
AD1	ITS Data Mart	Archived Data Management	Traffic and Roadside Data Archival
			ITS Data Repository
			Government Reporting System Support
		Roadway Subsystem	Roadway Data Collection
		Traffic Management	Traffic Data Collection
		Maintenance and Construction Management	MCM Data Collection
		Transit Management	Transit Data Collection
AD2	ITS Data Warehouse	Archived Data Management	ITS Data Repository
			Government Reporting System Support
		Maintenance and Construction Management	MCM Data Collection
		Emergency Management	Emergency Data Collection
APTS1	Transit Vehicle Tracking	Transit Management	Transit Center Tracking and Dispatch
		Transit Vehicle Subsystem	On-board Transit Trip Monitoring
		Vehicle Subsystem	Vehicle Location Determination
APTS2	Transit Fixed-Route Operations	Transit Management	Transit Center Fixed-Route Operations
			Transit Vehicle Operator Scheduling
		Transit Vehicle Subsystem	On-board Fixed Route Schedule Management
APTS3	Demand Response Transit Operations	Transit Management	Transit Center Paratransit Operations
		Transit Vehicle Subsystem	Transit Vehicle Operator Scheduling
APTS5	Transit Security	Transit Management	On-board Paratransit Operations
		Transit Vehicle Subsystem	Transit Center Security
		Emergency Management	On-board Transit Security
APTS6	Transit Maintenance	Transit Management	Center Secure Area Surveillance
		Transit Vehicle Subsystem	Transit Garage Maintenance
ATPS7	Multi-modal Coordination	Transit Management	On-board Maintenance
		Transit Vehicle Subsystem	Transit Center Multi-Modal Coordination
		Traffic Management	On-board Transit Signal Priority
		Roadway Subsystem	TMC Multimodal Coordination
APTS8	Transit Traveler Information	Transit Management	Roadway Signal Priority
		Remote Traveler Support	Transit Center Information Services
		Information Service Provider	Remote Transit Information Services
ATIS1	Broadcast Traveler Information	Information Service Provider	Interactive Infrastructure Information
			ISP Traveler Data Collection
		Personal Information Access	ISP Traveler Data Collection
			Personal Basic Information Reception

Market Package	Market Package Name	Subsystem	Equipment Package
ATIS2	Interactive Traveler Information	Information Service Provider	Traveler Telephone Information
			Interactive Infrastructure Information
		ISP Traveler Data Collection	
		Personal Information Access	Personal Interactive Information Reception
ATMS01	Network Surveillance	Traffic Management	Collect Traffic Surveillance
			Traffic Maintenance
		Roadway Subsystem	Roadway Basic Surveillance
ATMS03	Surface Street Control	Traffic Management	Collect Traffic Surveillance
			TMC Signal Control
			Traffic Maintenance
		Roadway Subsystem	Roadway Signal Controls
			Roadway Basic Surveillance
ATMS06	Traffic Information Dissemination	Traffic Management	TMC Traffic Information Dissemination
		Roadway Subsystem	Roadway Traffic Information Dissemination
ATMS08	Traffic Incident Management System	Traffic Management	TMC Incident Detection
			TMC Incident Dispatch Coordination/Communication
		Roadway Subsystem	Roadway Incident Detection
		Emergency Management	Emergency Response Management
			Incident Command
		Maintenance and Construction Management	MCM Incident Management
Emergency Vehicle Subsystem	On-board EV Incident Management Communication		
ATMS13	Standard Railroad Grade Crossing	Traffic Management	HRI Traffic Management
		Roadway Subsystem	Standard Rail Crossing
CVO04	CV Administrative Processes	Commercial Vehicle Administration	Credentials and Taxes Administration
			CV Information Exchange
CVO06	Weigh-In-Motion	Commercial Vehicle Check	Roadside WIM
		Commercial Vehicle Subsystem	On-board CV Electronic Data
CVO11	Roadside HAZMAT Security Detection and Mitigation	Commercial Vehicle Check	Roadside HAZMAT detection
EM01	Emergency Call-Taking and Dispatch	Emergency Management	Emergency Call-Taking
			Emergency Dispatch
		Emergency Vehicle Subsystem	On-board EV En Route Support
EM02	Emergency Routing	Emergency Management	Emergency Routing
		Emergency Vehicle Subsystem	On-board EV En Route Support

Market Package	Market Package Name	Subsystem	Equipment Package
		Traffic Management	TMC Incident Dispatch Coordination/Communication
		Roadway Subsystem	Roadway Signal Priority
		Vehicle Subsystem	Vehicle Location Determination
EM05	Transportation Infrastructure Protection	Emergency Management	Center Secure Area Surveillance
		Security Monitoring Subsystem	Traveler Secure Area Surveillance
EM06	Wide-Area Alert	Emergency Management	Emergency Early Warning System
		Information Service Provider	ISP Emergency Traveler Information ISP Traveler Data Collection
		Personal Information Access	Personal Basic Information Reception
		Traffic Management	TMC Traffic Information Dissemination
		Roadway Subsystem	Roadway Traffic Information Dissemination
EM08	Disaster Response and Recovery	Emergency Management	Emergency Response Management Incident Command
		Maintenance and Construction Management	MCM Incident Management MCM Roadway Maintenance and Construction
		Transit Management	Transit Center Security
		Traffic Management	TMC Incident Dispatch Coordination/Communication
EM09	Evacuation and Reentry Management	Emergency Management	Emergency Evacuation Support
		Traffic Management	TMC Evacuation Support
		Transit Management	Transit Evacuation Support
		Maintenance and Construction Management	MCM Incident Management
EM10	Disaster Traveler Information	Information Service Provide	ISP Emergency Traveler Information ISP Traveler Data Collection Traveler Telephone Information
		Emergency Management	Emergency Evacuation Support Emergency Response Management
MC01	Maintenance and Construction Vehicle and Equipment Tracking	Maintenance and Construction Management	MCM Vehicle Tracking
		Maintenance and Construction Vehicle	MCV Vehicle Location Tracking
		Vehicle Subsystem	Vehicle Location Determination
MC02	Maintenance and Construction Vehicle Maintenance	Maintenance and Construction Management	MCM Vehicle and Equipment Maintenance Management
MC03	Road Weather Data Collection	Maintenance and Construction Management	MCM Environmental Information Collection
		Emergency Management	Emergency Environmental Monitoring

Market Package	Market Package Name	Subsystem	Equipment Package
		Roadway Subsystem	Roadway Environmental Monitoring
MC04	Weather Information Processing and Distribution	Maintenance and Construction Management	MCM Environmental Information Processing
		Information Service Provider	ISP Traveler Data Collection
MC05	Roadway Automated Treatment	Maintenance and Construction Management	MCM Automated Treatment System Control
		Roadway Subsystem	Roadway Automated Treatment
MC06	Winter Maintenance	Maintenance and Construction Management	MCM Maintenance Decision Support
			MCM Winter Maintenance Management
		Maintenance and Construction Vehicle	MCV Winter Maintenance
		Traffic Management	TMC Incident Dispatch Coordination/Communication
MC07	Roadway Maintenance and Construction	Maintenance and Construction Management	MCM Maintenance Decision Support
			MCM Roadway Maintenance and Construction
		Maintenance and Construction Vehicle	MCV Roadway Maintenance and Construction
		Traffic Management	Traffic Maintenance
MC08	Work Zone Management	Maintenance and Construction Management	MCM Work Zone Management
		Roadway Subsystem	Roadway Work Zone Traffic Control
MC10	Maintenance and Construction Activity Coordination	Maintenance and Construction Management	MCM Work Activity Coordination
		Emergency Management	Emergency Response Management

6.2 Functional Requirements

A functional requirement is a task or activity that is currently performed or is planned to be preformed by each system in the region to provide the required regional ITS services. In the National ITS Architecture, each functional area (i.e. equipment package) has defined several specific functional requirements that are required for performing the equipment package capabilities. These specific functional requirements of the National ITS Architecture are commonly used as a baseline to develop the functional requirements of a regional ITS architecture.

The process to develop the functional requirements of the AAMPO Regional ITS Architecture begins with the mapping of functional areas to market packages and associated elements as an initial definition of the functions being performed by each element. The functional requirements of each equipment package were then tailored to provide a more accurate picture of the functions

performed. Using Turbo Architecture, functional requirements that support the ITS projects for the region were identified. These functional requirements are listed in Appendix B. The Appendix includes the following information for each ITS element:

- **Element.** Name of the system that will be performing the function
- **Entity.** Describes the National ITS Architecture subsystem to which the element is mapped
- **Functional Area.** Description of the function performed by the element
- **Requirement.** High-level functional requirement to be performed by the element supporting the functional area

To illustrate functions and functional requirements, the traffic monitoring function of the City of Ames Public Works is used as an example. In the AAMPO Regional ITS Architecture, the City of Ames Public Works was mapped to the Traffic Management subsystem as it provides traffic monitoring and control functions. The market package associated with these functions is ATMS01 – Network Surveillance. Two functional areas (equipment packages) are required for the City of Ames Public Works to perform the network surveillance capability. They are:

- **Collect Traffic Surveillance:** This equipment package remotely monitors and controls traffic sensors and surveillance (e.g., CCTV) equipment, and collects, processes and stores the collected traffic data. The collected information is provided to traffic operations personnel and made available to other centers.
- **Traffic Maintenance:** This equipment package monitors the operational status of field equipment and detects failures. It presents field equipment status to Traffic Operations Personnel and reports failures to the Maintenance and Construction Management Subsystem. The equipment package tracks the repair or replacement of the failed equipment. The entire range of ITS field equipment may be monitored by this equipment package including sensors (traffic, infrastructure, environmental, security, speed, etc.) and devices (highway advisory radio, dynamic message signs, automated roadway treatment systems, barrier and safeguard systems, cameras, traffic signals and override equipment, ramp meters, beacons, security surveillance equipment, etc.).

In the National ITS Architecture, the Collect Traffic Surveillance equipment package contains seven specific functional requirements and the Traffic Maintenance equipment package has eight. However, not all of the functional requirements are applicable to the City of Ames Public Works. The appropriate functional requirements for each equipment package were tailored and identified in the Table 6-2.

**Table 6-2. Functional Requirements Example:
City of Ames Public Works Network Surveillance**

Functional Area (Equipment Package)	Functional Requirements	Status
Collection Traffic Surveillance	The center shall monitor, analyze, and store traffic sensor data collected from field elements under remote control of the center.	Existing
	The center shall monitor, analyze, and distribute traffic images from CCTV systems under remote control of the center.	Existing
	The center shall distribute road network conditions data (raw or processed) based on collected and analyzed traffic sensor and surveillance data to other centers.	Existing
	The center shall respond to control data from center personnel regarding sensor and surveillance data collection, analysis, storage, and distribution.	Existing
	The center shall maintain a database of surveillance and sensors and the freeways, surface street and rural roadways, e.g. where they are located, to which part(s) of the network their data applies, the type of data, and the ownership of each link (that is, the agency or entity responsible for collecting and storing surveillance of the link) in the network.	Existing
Traffic Maintenance	The center shall collect and store sensor (traffic, pedestrian, multimodal crossing) operational status.	Existing
	The center shall collect and store CCTV surveillance system (traffic, pedestrian) operational status.	Existing
	The center shall collect and store sensor (traffic, pedestrian, multimodal crossing) fault data and send to the maintenance center for repair.	Existing
	The center shall collect and store CCTV surveillance system (traffic, pedestrian) fault data send to the maintenance center for repair.	Existing
	The center shall exchange data with maintenance centers concerning the reporting of faulty equipment and the schedule/status of their repair. Information exchanged includes details of new equipment faults, and clearances when the faults are cleared.	Existing

7. INTERCONNECTS AND ARCHITECTURE FLOWS

While it is important to identify the various ITS systems and associated stakeholders, a primary purpose of the AAMPO Regional ITS Architecture is to identify the *connectivity* between systems. Architecture interconnects define an ITS architecture from a physical perspective, which shows the connections that can be established between equipment and systems which may be deployed by different organizational or operating agencies throughout the region. Architecture flows define an ITS architecture from a logical perspective, which identify a high level information exchange associated with each interconnect between equipment and systems.

7.1 System Interconnects

Based on subsystems and market packages that are selected for each ITS inventory element, a set of interconnects between the elements have been identified. As shown in Figure 7-1, a high-level interconnect diagram for the AAMPO Regional ITS Architecture, often referred to as a “sausage diagram,” illustrates the subsystems and primary types of interconnections (or communications) between these subsystems. The sausage diagram was customized to reflect the ITS systems in the region. The shaded areas in Figure 7-1 indicate the functions and services that are not currently existing and planned in the region. The sausage diagram identifies three basic types of communications used to interconnect the elements. The definitions of the three types of communications are:

- **Fixed Point to Fixed Point Communications:** a communication link serving stationary entities. It may be implemented using a variety of public or private communication networks and technologies. It can include, but is not limited to, twisted pair, coaxial cable, fiber optic, microwave relay networks, spread spectrum, etc. In Fixed-Point to Fixed-Point communication the important issue is that it serves stationary entities. Both dedicated and shared communication resources may be used.
- **Wide Area Wireless Communications:** a communications link that provides communications via a wireless device between a user and an infrastructure-based system. Both broadcast (one-way) and interactive (two-way) communications services are grouped into wide-area wireless communications in the National ITS Architecture. These links support a range of services in the National ITS Architecture including real-time traveler information and various forms of fleet communications.
- **Dedicated Short Range Communications:** a wireless communications channel used for close-proximity communications between vehicles and the immediate infrastructure. It supports location-specific communications for ITS capabilities such as toll collection, transit vehicle management, driver information, and automated commercial vehicle operations.

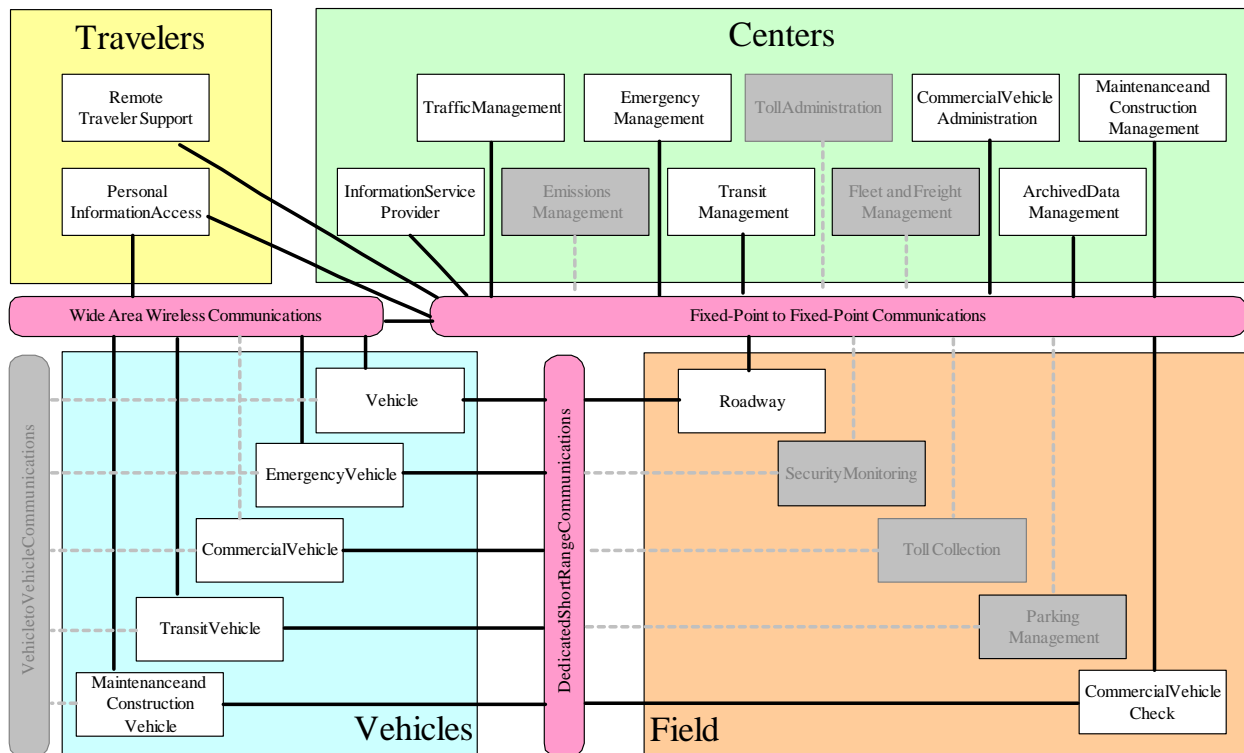

Figure 7-1. AAMPO Regional ITS Architecture Sausage Diagram

On a more specific level, interconnect diagrams can depict the interactions between a specific element and other associated agencies and their systems within the architecture. Figures 7-2 to 7-8 illustrate interconnects focused on the following key regional ITS elements:

- City of Ames Public Works
- City of Ames CyRide
- Story County Sheriff Communications Center
- City of Ames Police Communications Center
- Iowa State University Police Communications Center
- Iowa State Patrol Des Moines Communications Center
- Iowa DOT Ames Maintenance Garage

A complete set of the interconnect diagrams for the AAMPO Regional ITS Architecture is included in Appendix C and can also be found in the Turbo Architecture database.

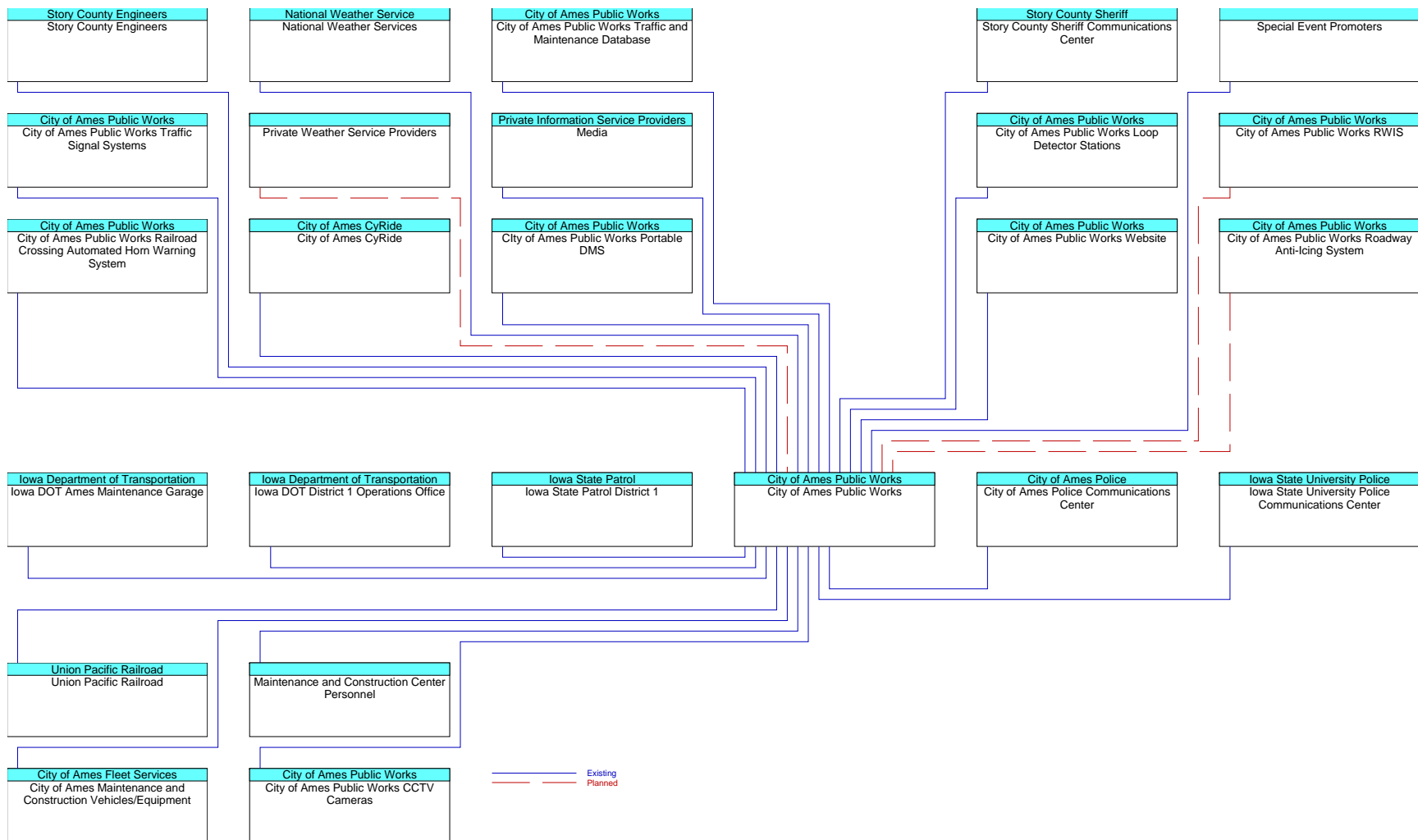

Figure 7-2. Interconnect Diagram: City of Ames Public Works

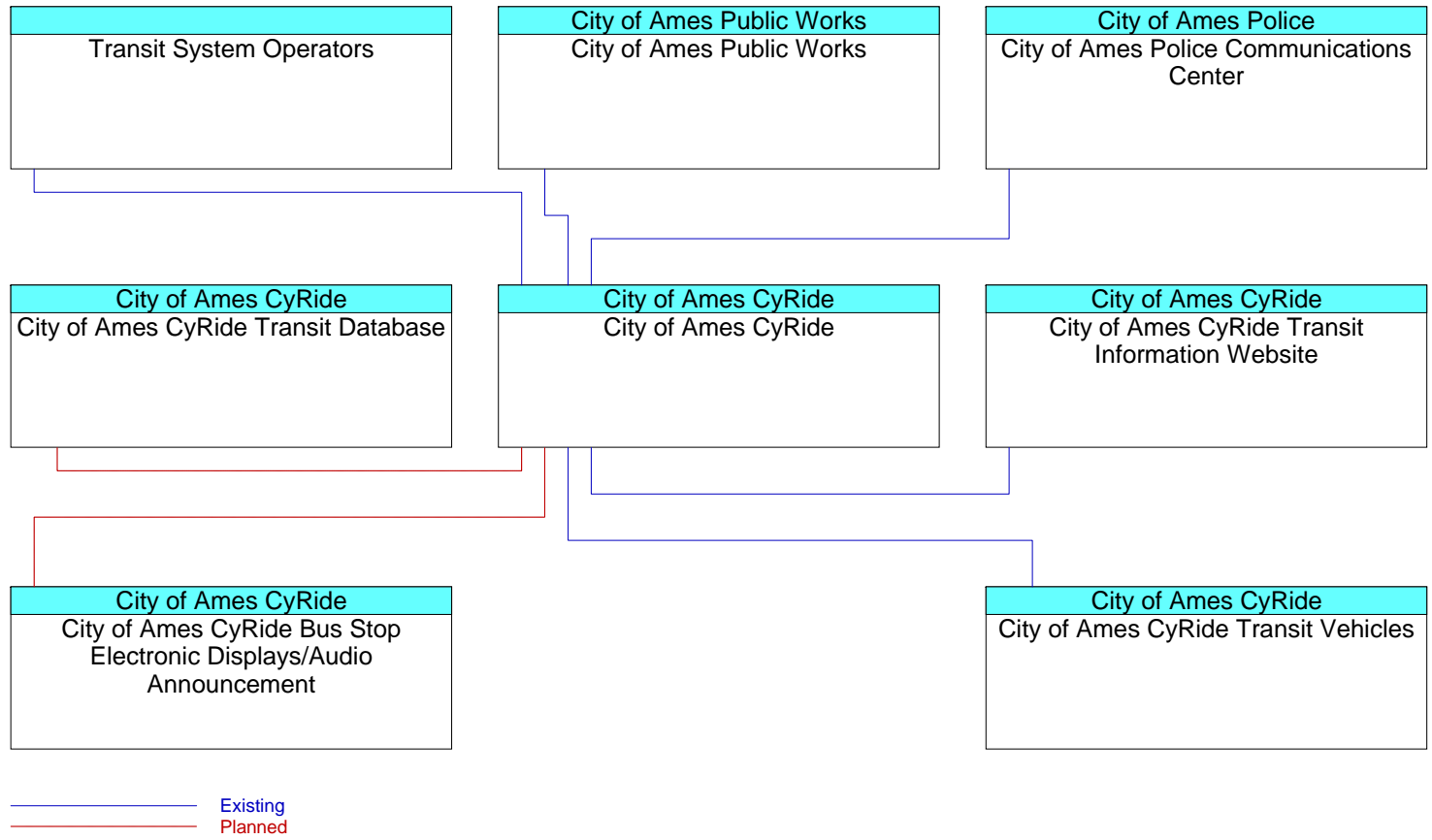

Figure 7-3. Interconnect Diagram: City of Ames CyRide

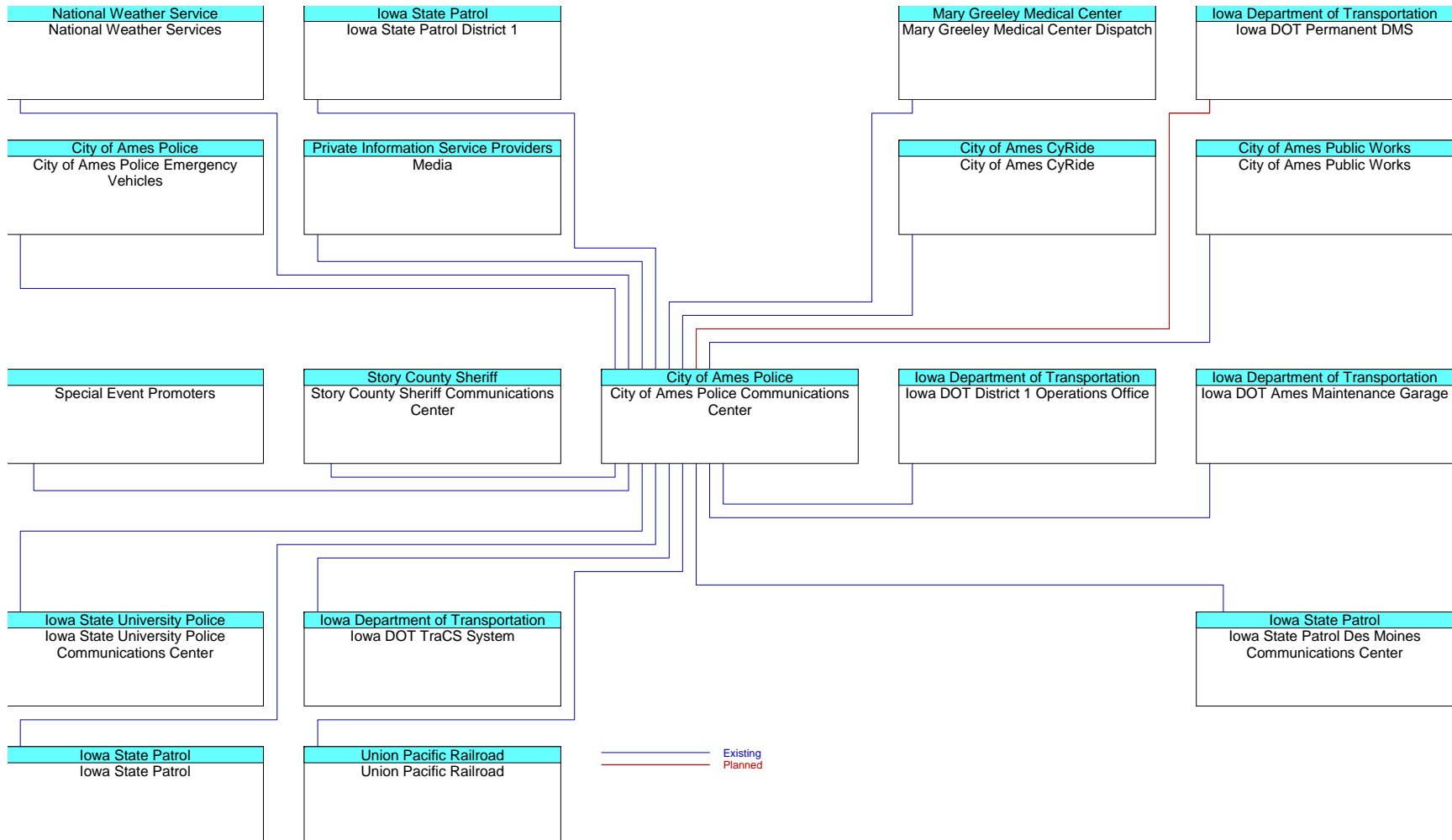

Figure 7-4. Interconnect Diagram: City of Ames Police Communications Center

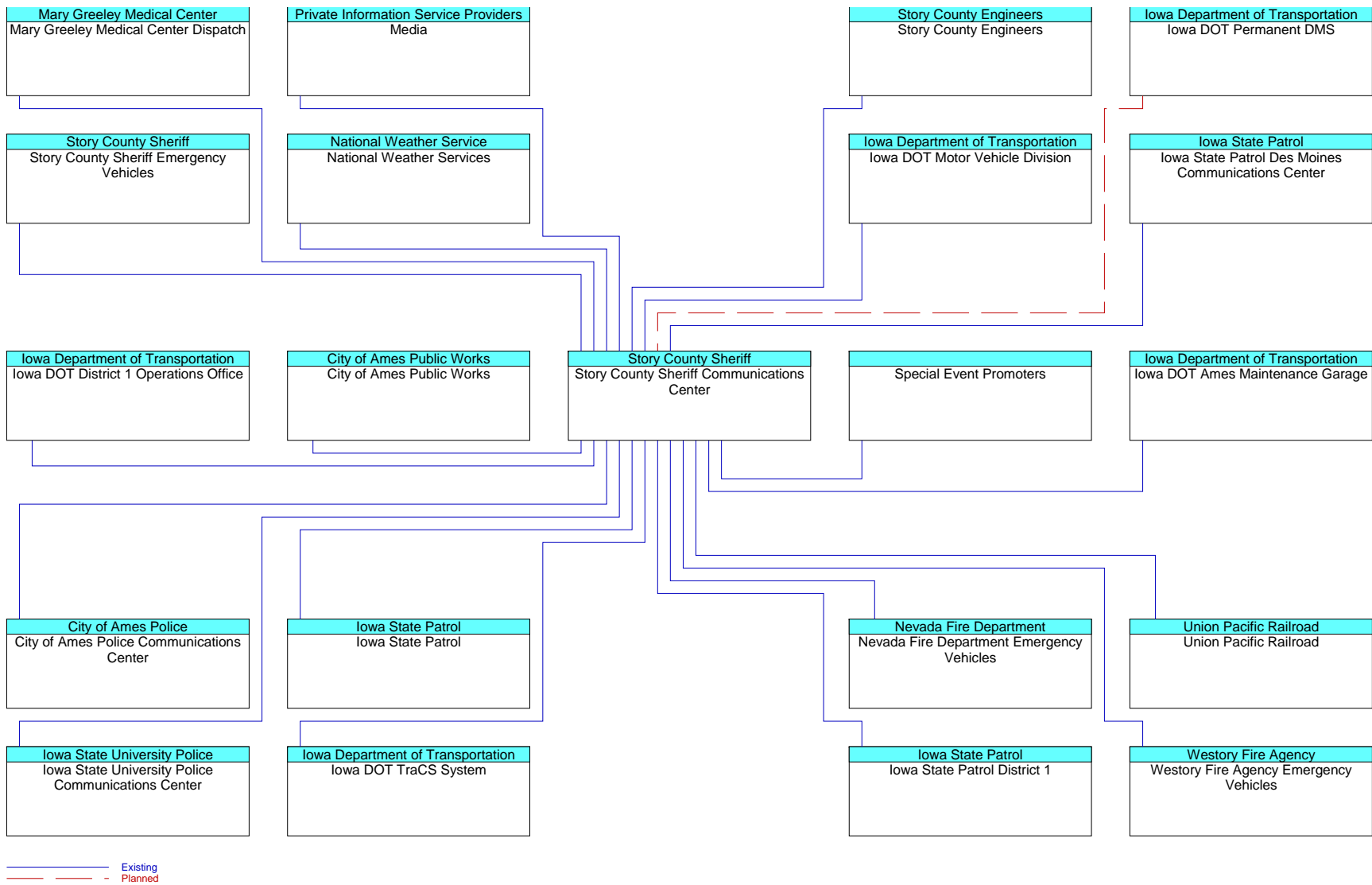

Figure 7-5. Interconnect Diagram: Story County Sheriff Communications Center

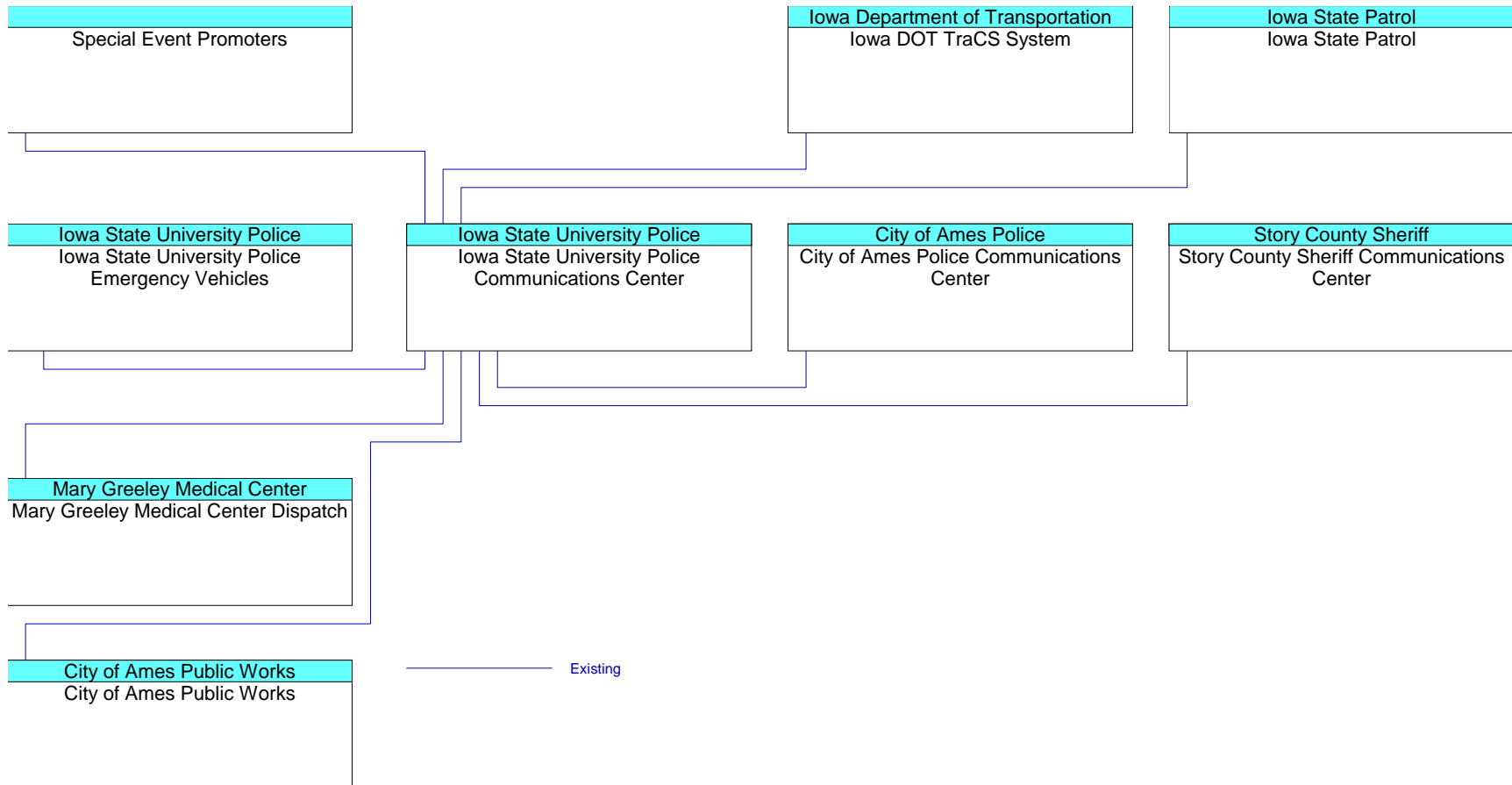

Figure 7-6. Interconnect Diagram: Iowa State University Police Communications Center

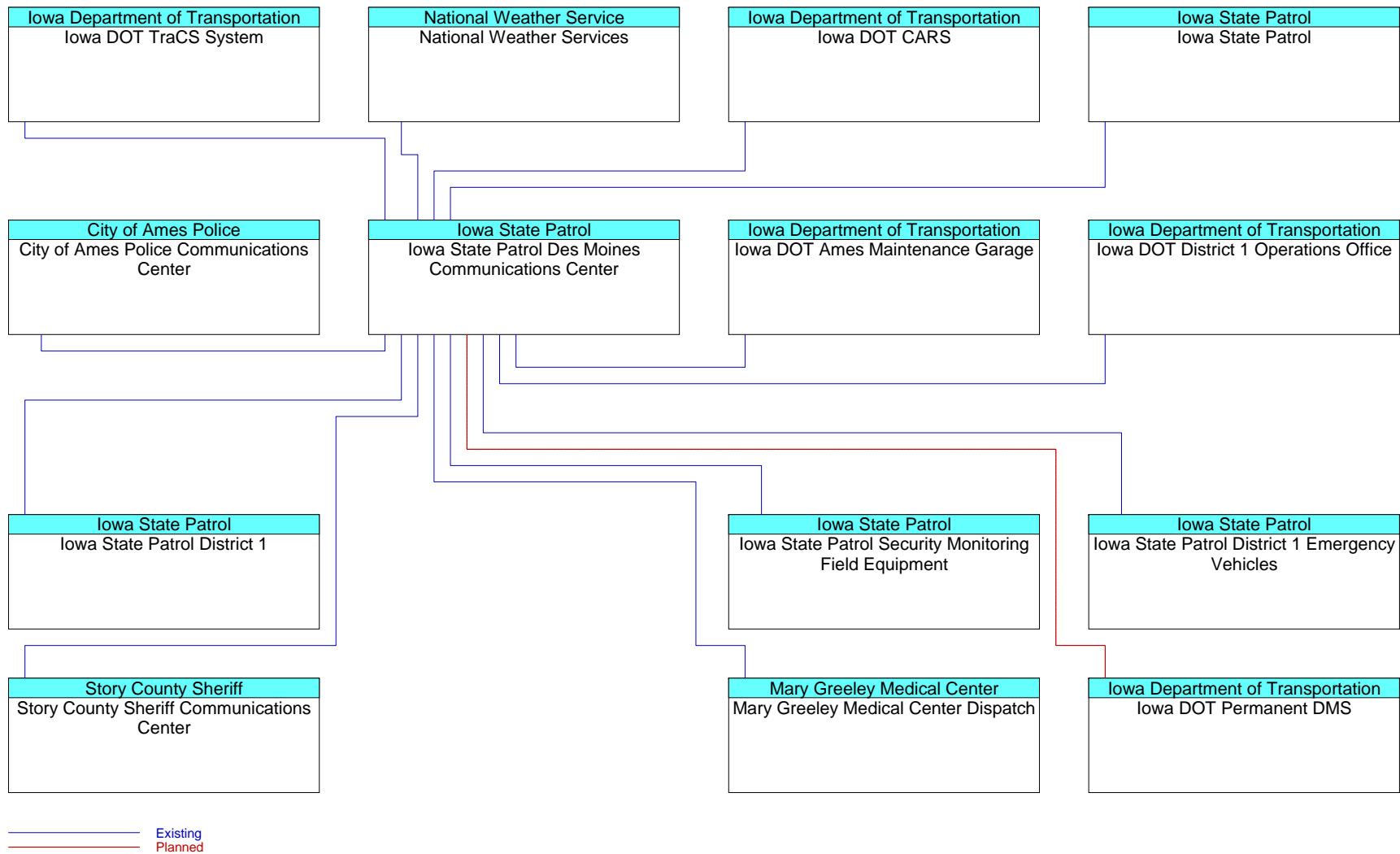

Figure 7-7. Interconnect Diagram: Iowa State Patrol Des Moines Communications Center

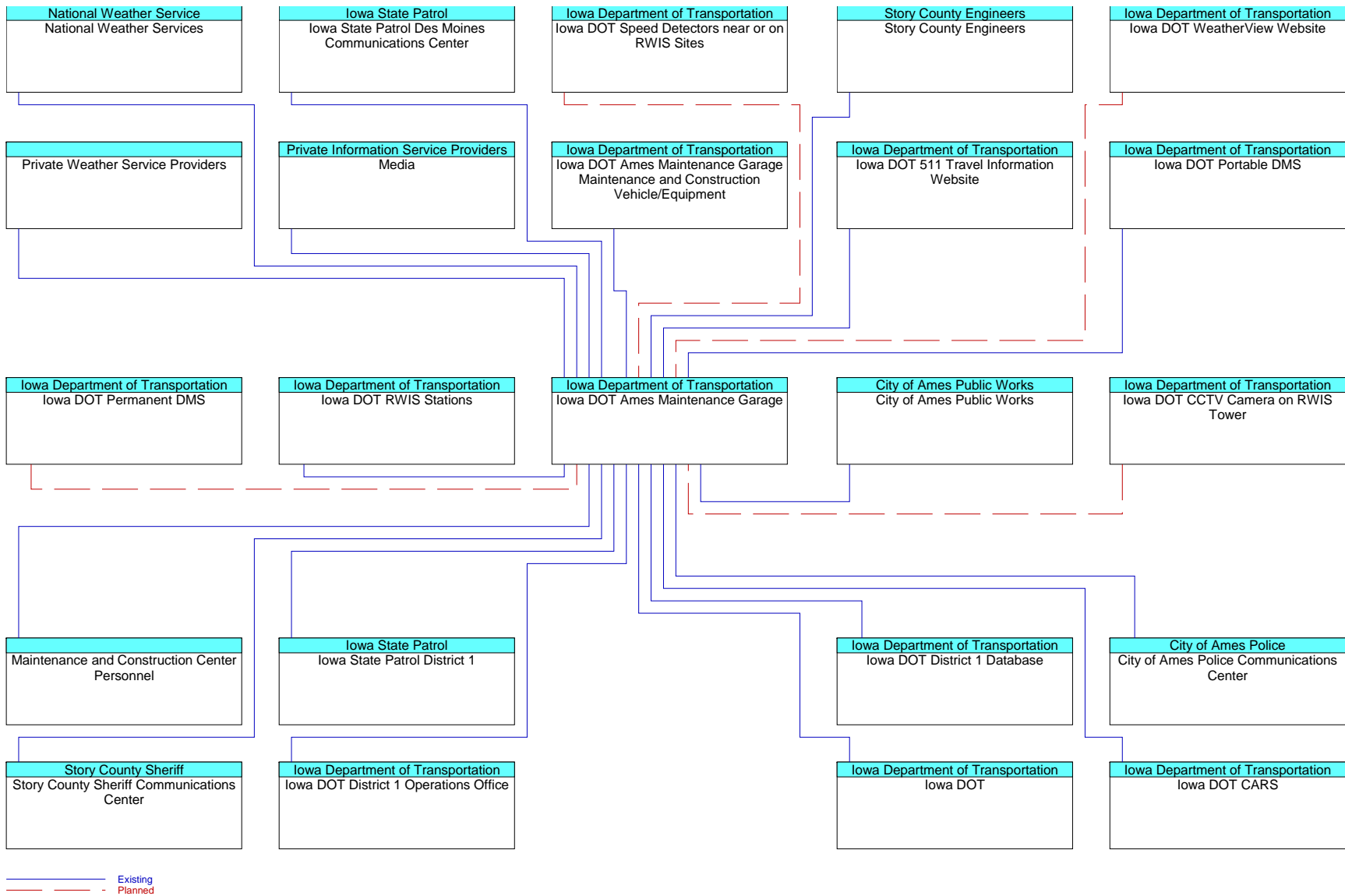

Figure 7-8. Interconnect Diagram: Iowa DOT Ames Maintenance Garage

7.2 Architecture Flows

Architecture flows provide a high level description of information exchange associated with each interconnect between equipment and systems. The architecture flows identified in the AAMPO Regional ITS Architecture were derived from the architecture flow diagrams within the National ITS Architecture, and therefore, they are consistent with the National ITS Architecture. Through the architecture flows, stakeholders can easily identify the existing or potential information exchange between agencies and systems. This provides a framework for analyzing how elements are related and thereby to identify the areas for potential coordination and cooperation among agencies. Detailed definitions of architecture flows can be found at the National ITS Architecture website at <http://www.iteris.com/itsarch/>. The architecture flow diagrams for the previous selected interconnect elements are presented in Figures 7-9 to 7-15. A complete list of architecture flows for the AAMPO Regional ITS Architecture is provided in Appendix D and can be found in the Turbo Architecture database.

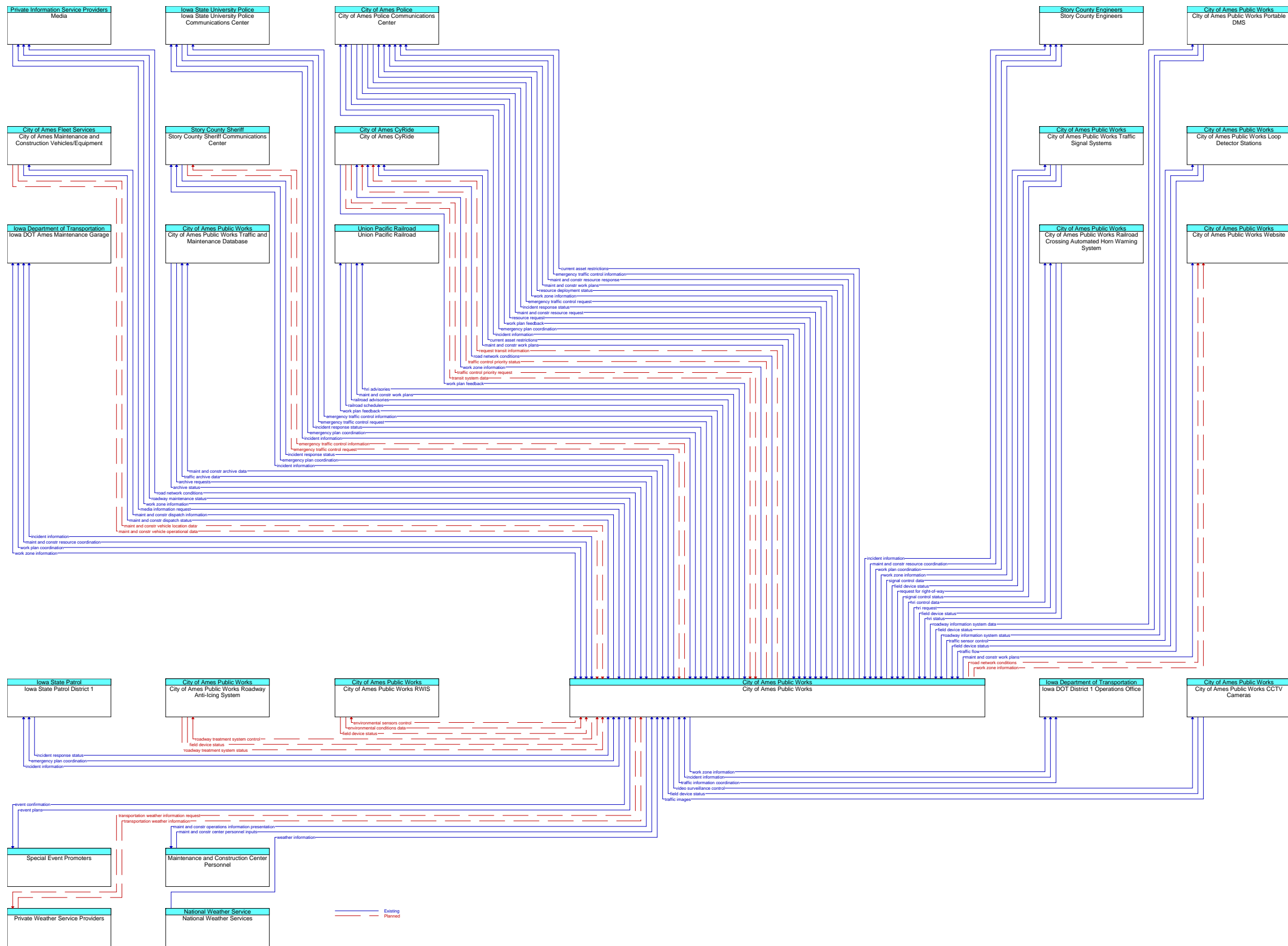

Figure 7-9. Architecture Flow Diagram: City of Ames Public Works

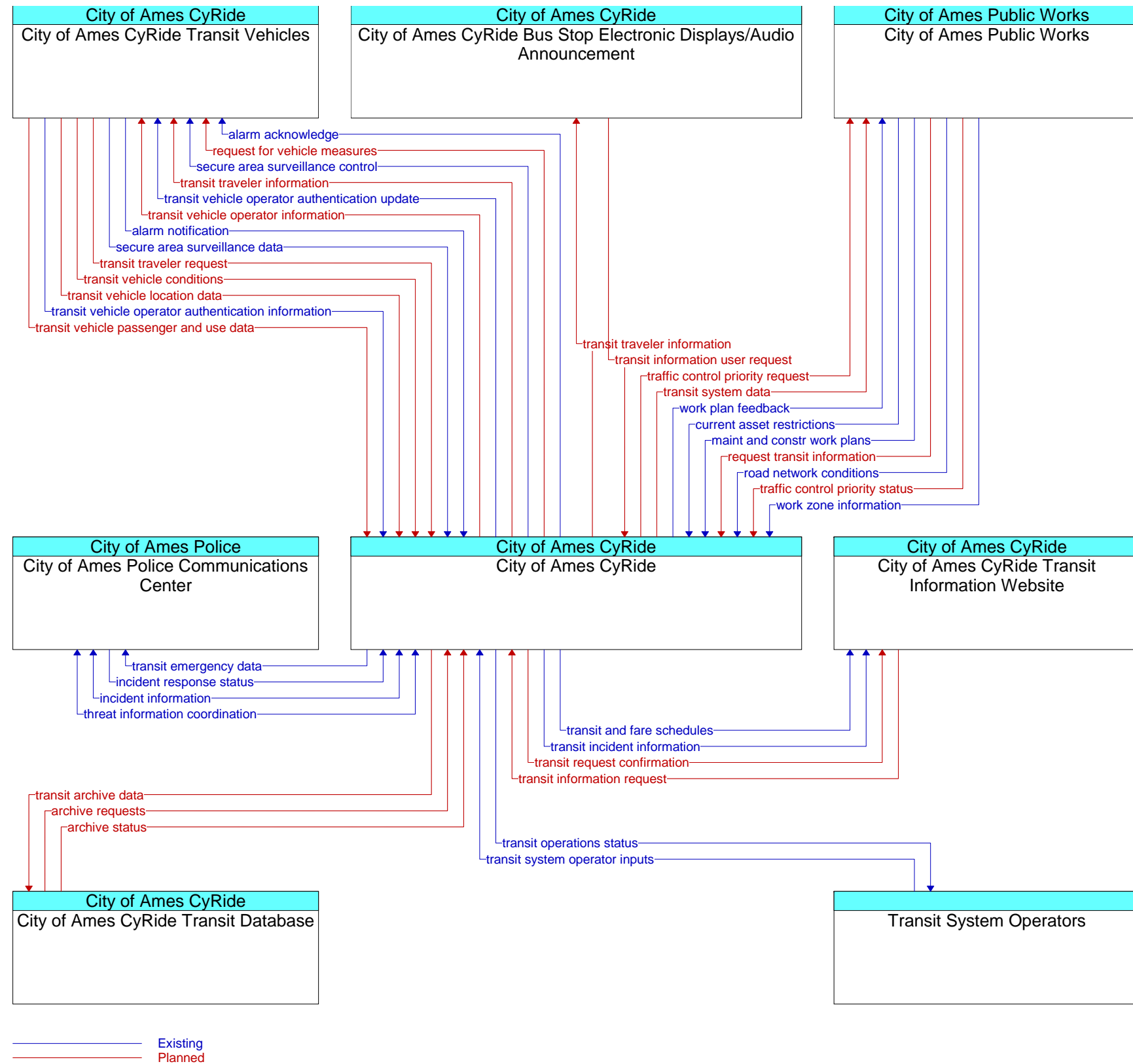

Figure 7-10. Architecture Flow Diagram: City of Ames CyRide

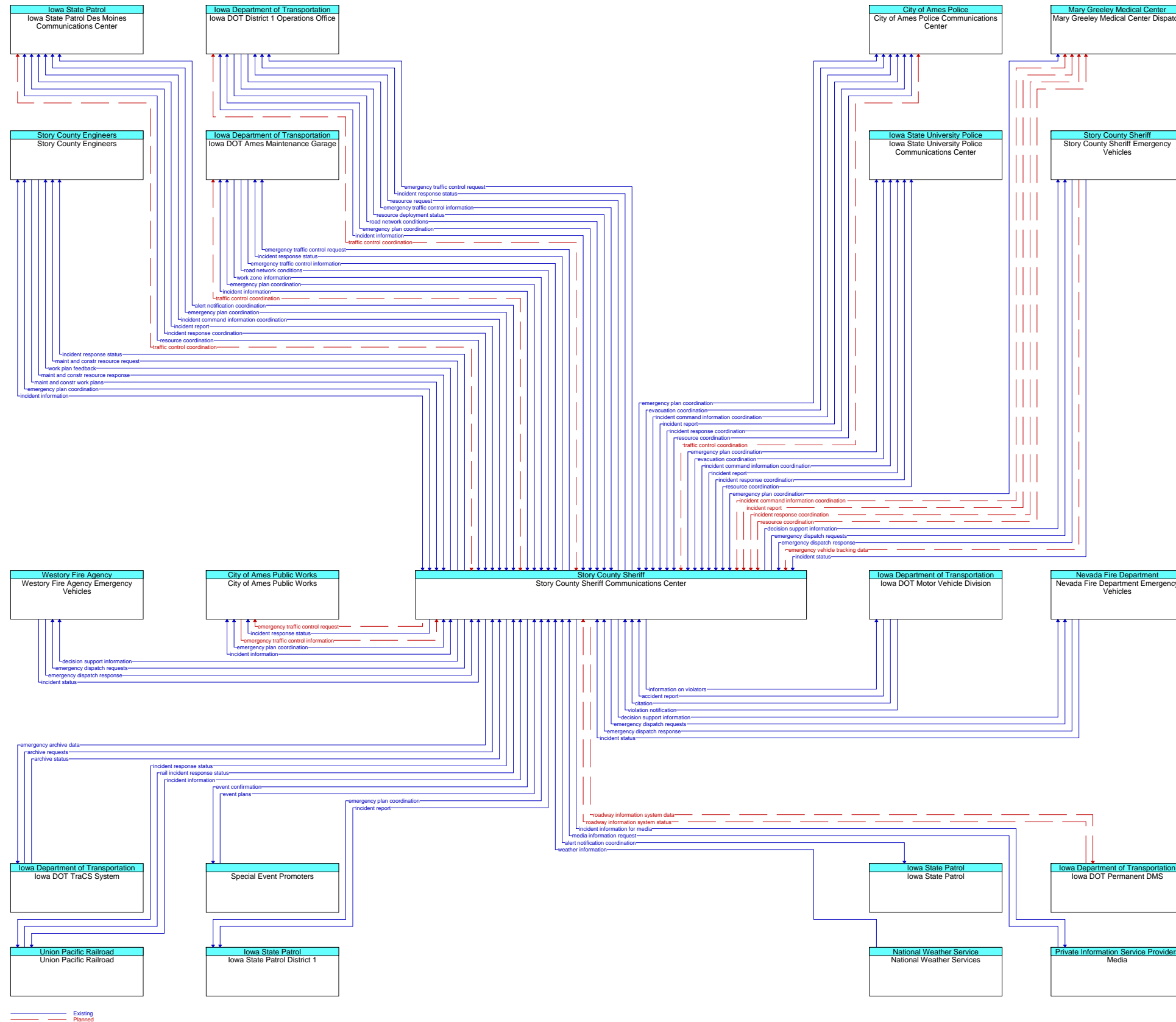

Figure 7-11. Architecture Flow Diagram: Story County Sheriff Communications Center

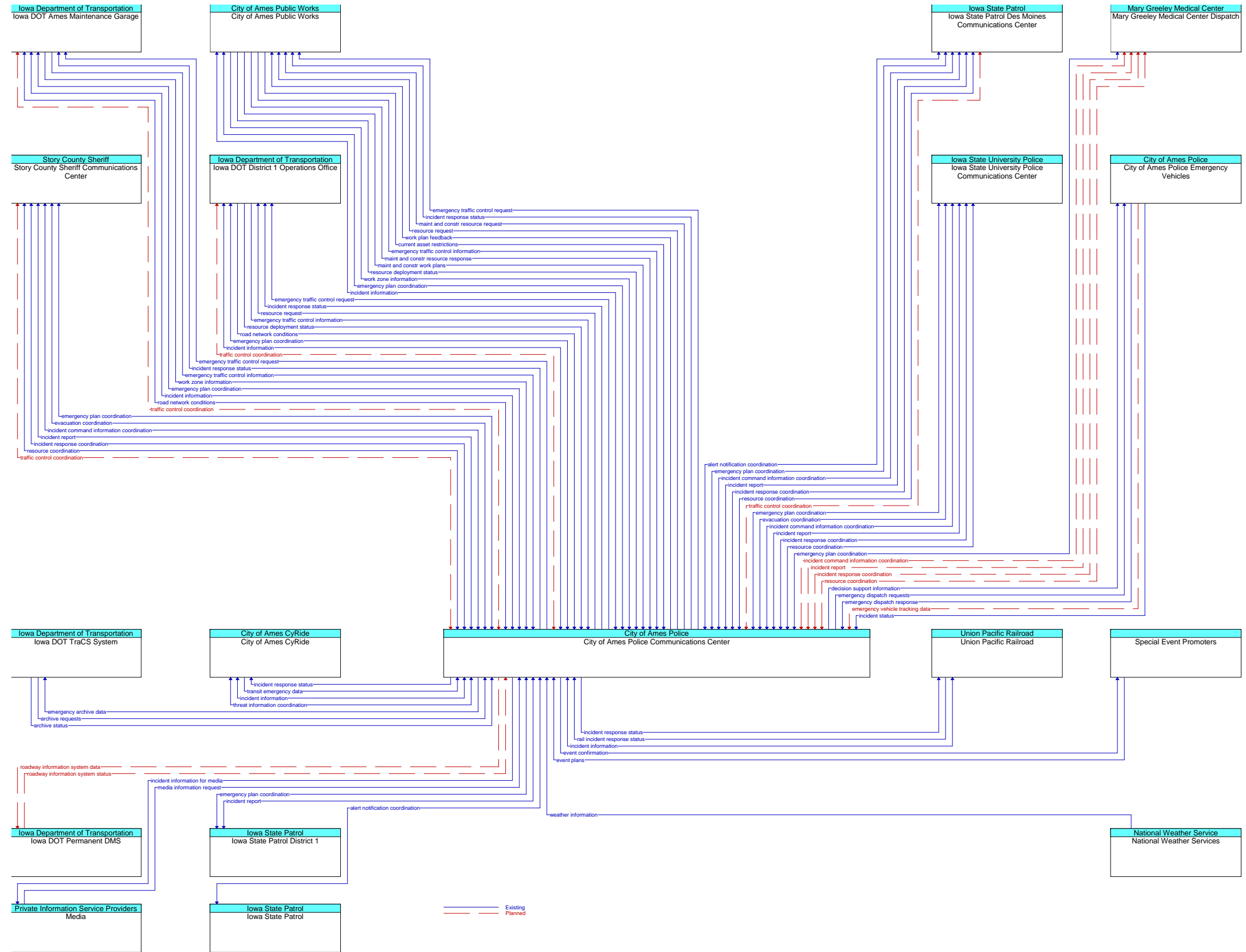

Figure 7-12. Architecture Flow Diagram: City of Ames Police Communications Center

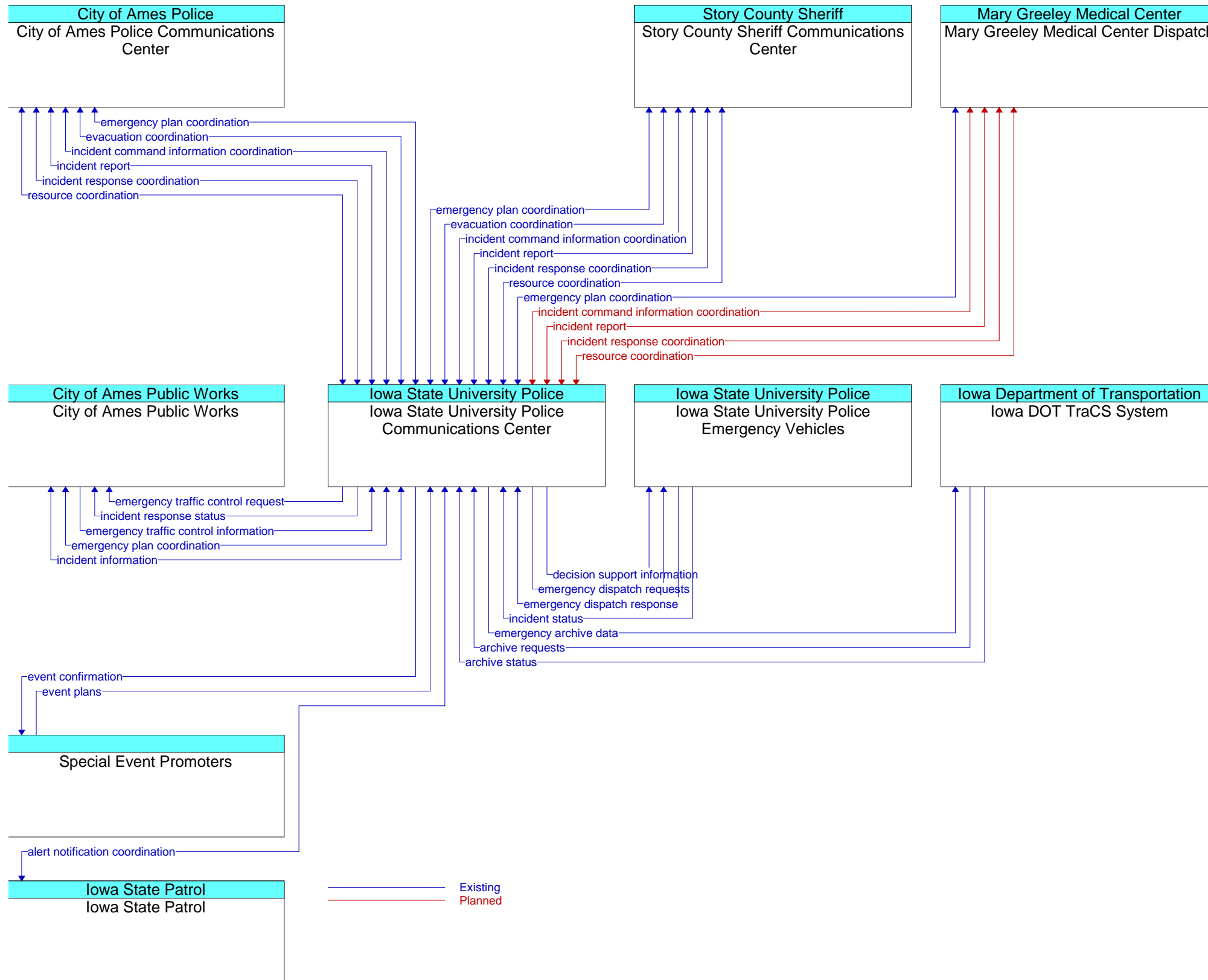

Figure 7-13. Architecture Flow Diagram: Iowa State University Police Communications Center

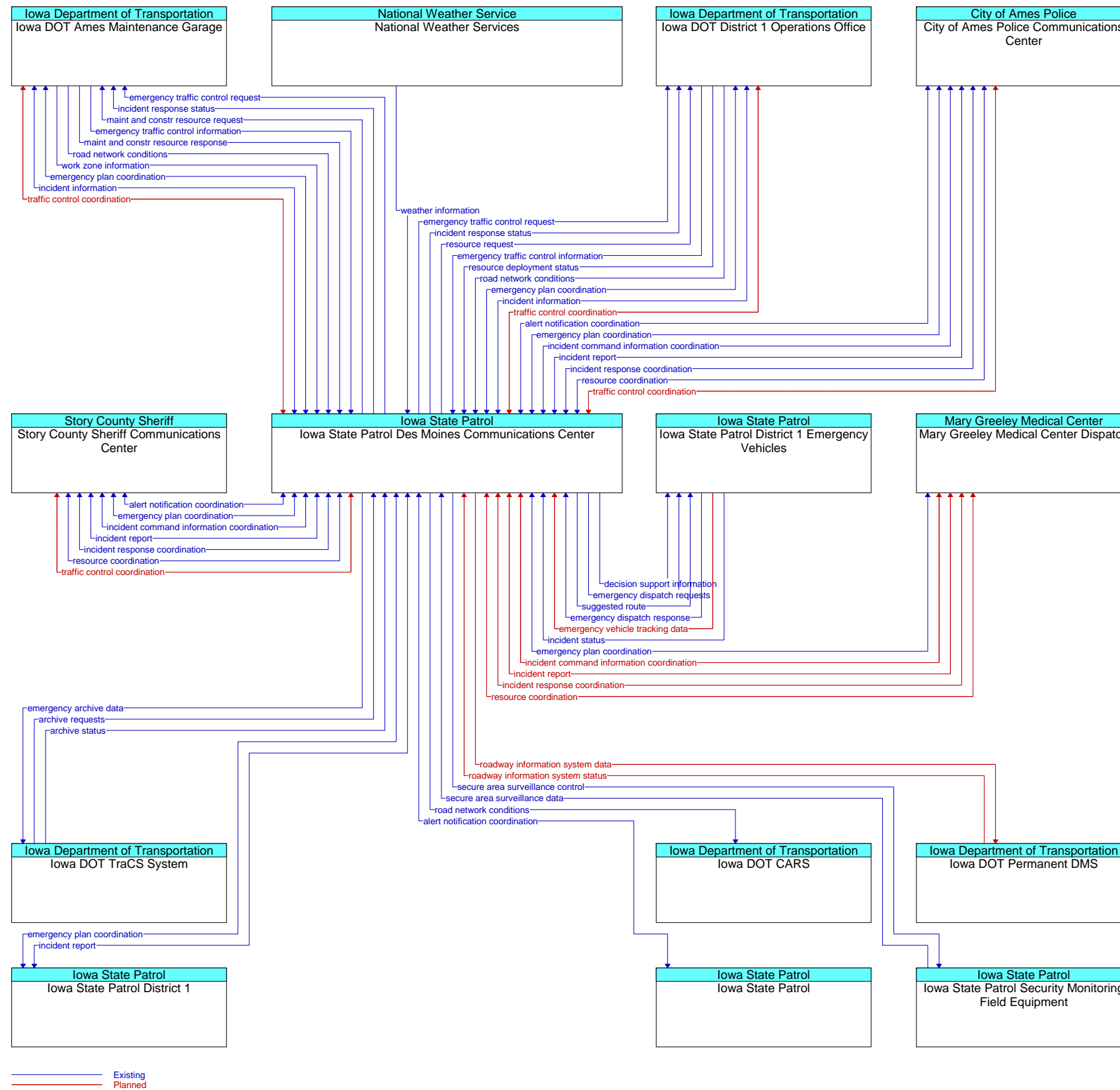

Figure 7-14. Architecture Flow Diagram: Iowa State Patrol Des Moines Communications Center

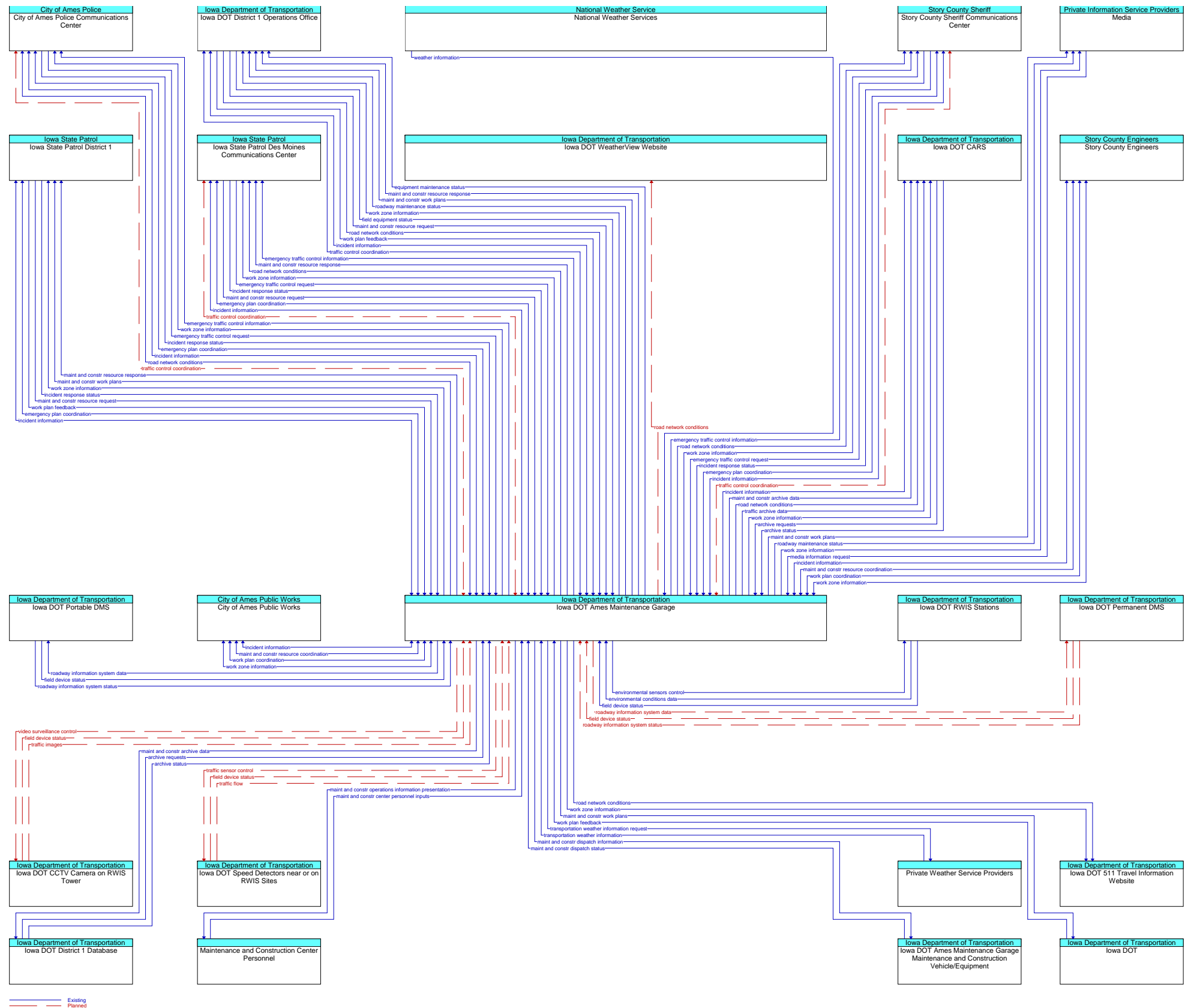

Figure 7-15. Architecture Flow Diagram: Iowa DOT Ames Maintenance Garage

7.3 High-Level Architectures for Selected Projects

High-level project architectures have been developed for the planned projects in the region. The project architectures illustrate the interfaces and interactions between the subsystem/terminators for the planned projects. A list of planned ITS projects has been identified and can be found in Section 9. The following pages present a series of architecture flow diagrams for the selected near-term ITS projects that have been planned to date. These architecture flow diagrams illustrate the interfaces and interactions between the subsystems/terminators for those projects.

Iowa DOT CCTV on RWIS Tower

This project will install a CCTV camera on the existing RWIS tower on I-35 north of US 30. The camera can provide images of the roadway that can be used by maintenance managers and the traveling public to observe the conditions of the road and traffic flow. The WeatherView website will be upgraded to include camera images. Figure 7-16 illustrated the project architecture flow diagram.

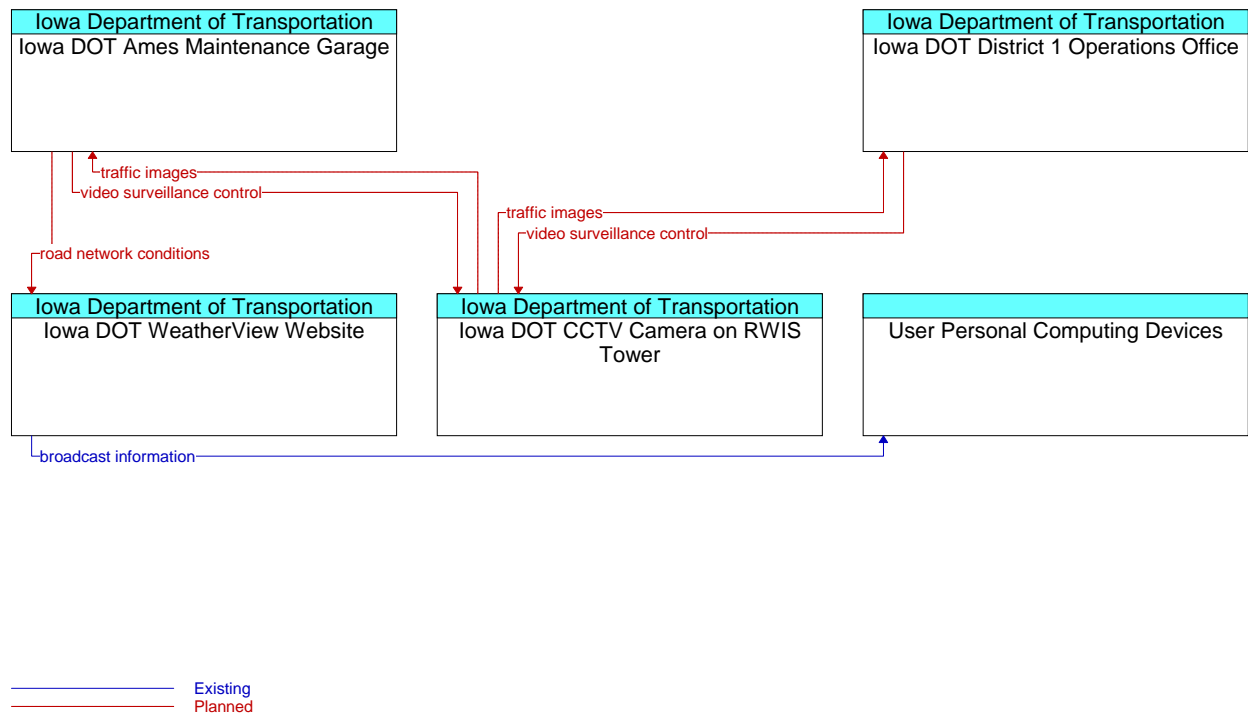

Figure 7-16. Project Architecture: Iowa DOT CCTV on RWIS Tower

Iowa DOT Permanent DMS

This project will install a DMS at I-35 south of US 30 for northbound traffic in 2006. DMS is expected to alert travelers to changing road conditions and other events such as AMBER alerts and homeland security status. Figure 7-17 illustrated the project architecture flow diagram.

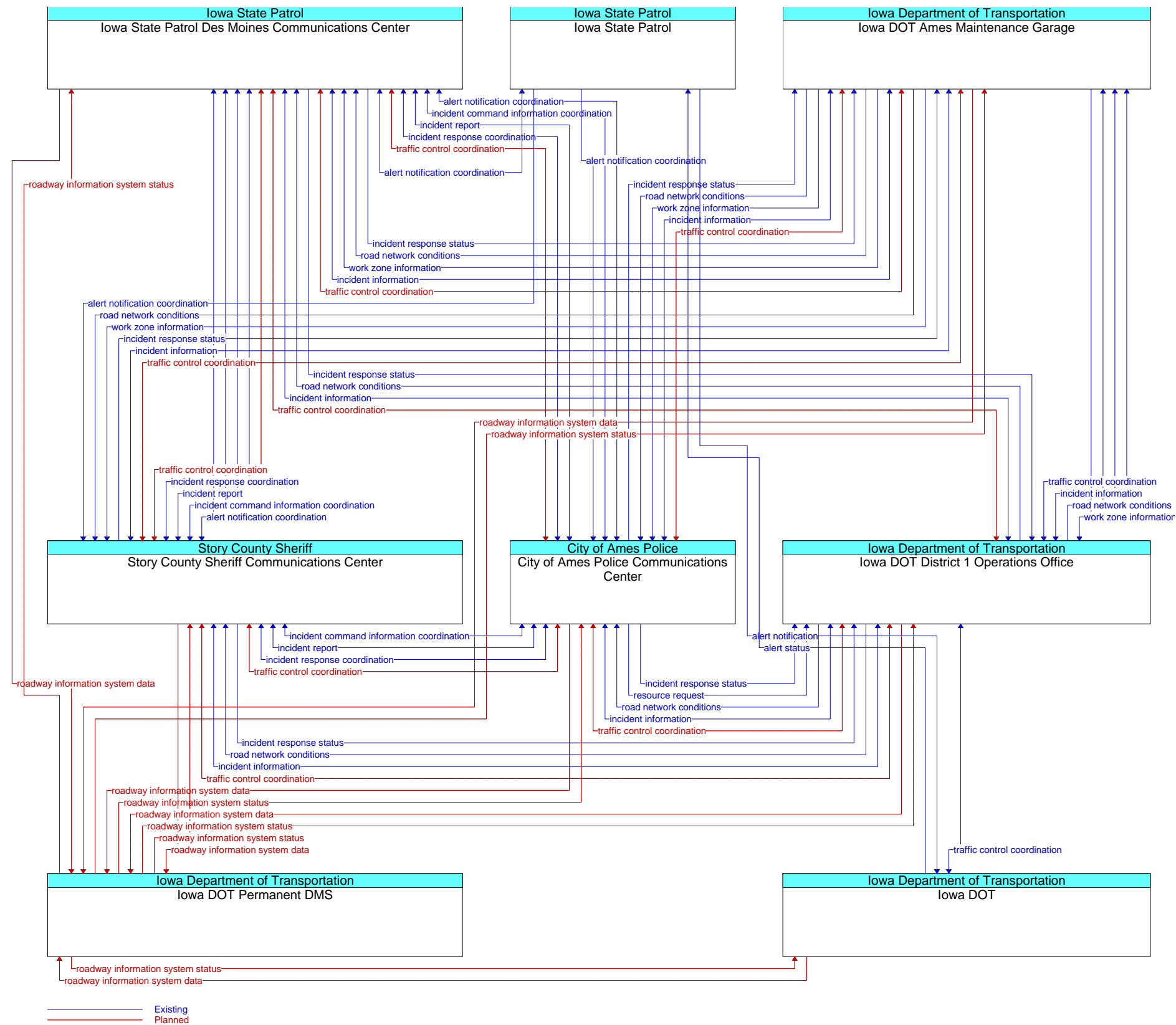

Figure 7-17. Project Architecture: Iowa DOT Permanent DMS

Iowa DOT Precipitation and Visibility Sensors

This project will update existing RWIS sensors to optical weather identifiers and visibility detectors or other accurate, versatile precipitation identification equipment. Improved precipitation observations will help maintenance managers and forecasters track the path and characteristics of precipitation. Visibility detection performance will be tested to determine if the observations can be used as a guide for road closures. Visibility measurements will also be provided to travelers through the Iowa DOT's WeatherView website. Figure 7-18 provided the architecture flow diagram for this project.

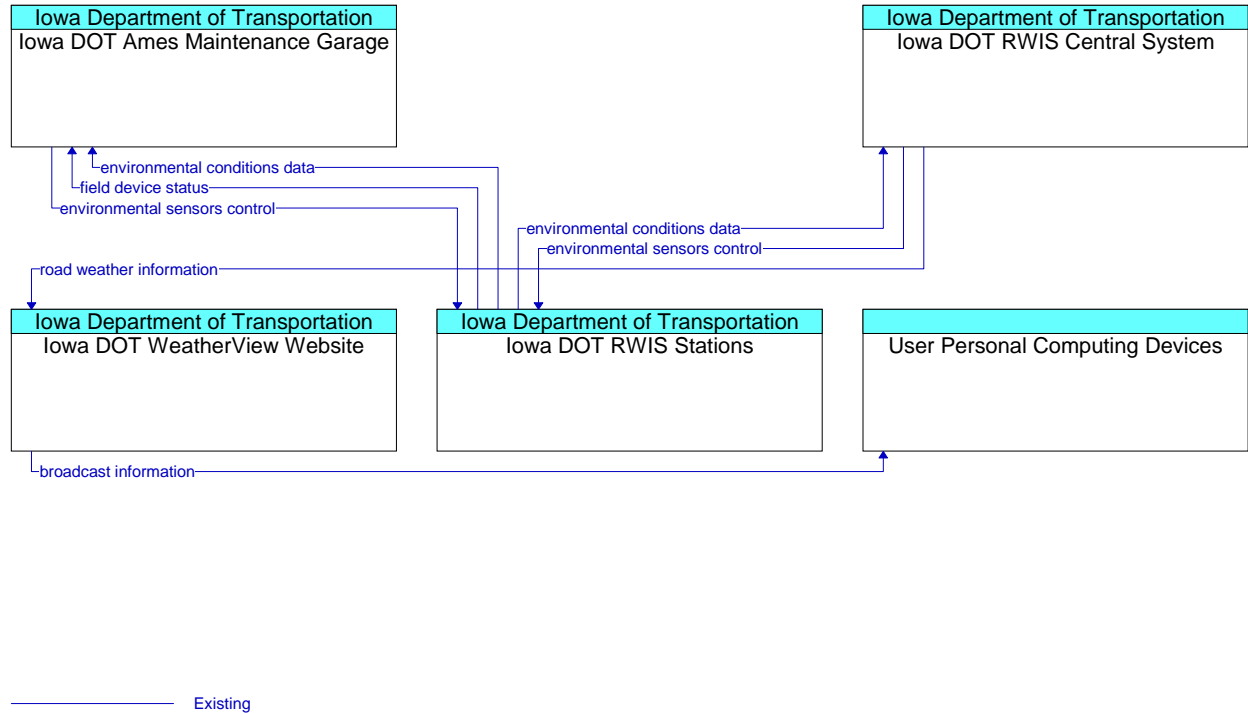

Figure 7-18. Project Architecture: Iowa DOT Precipitation and Visibility Sensors

Iowa DOT Speed Sensors at RWIS Site

This project plans to install speed detectors near or at the existing RWIS site. Speed information can be used to assess winter maintenance performance, the effects of certain weather events on traffic flow, and monitor the current traffic flow for the traveling public. The WeatherView website will be upgraded to include speed information. The architecture flow diagram for this project is shown in Figure 7-19.

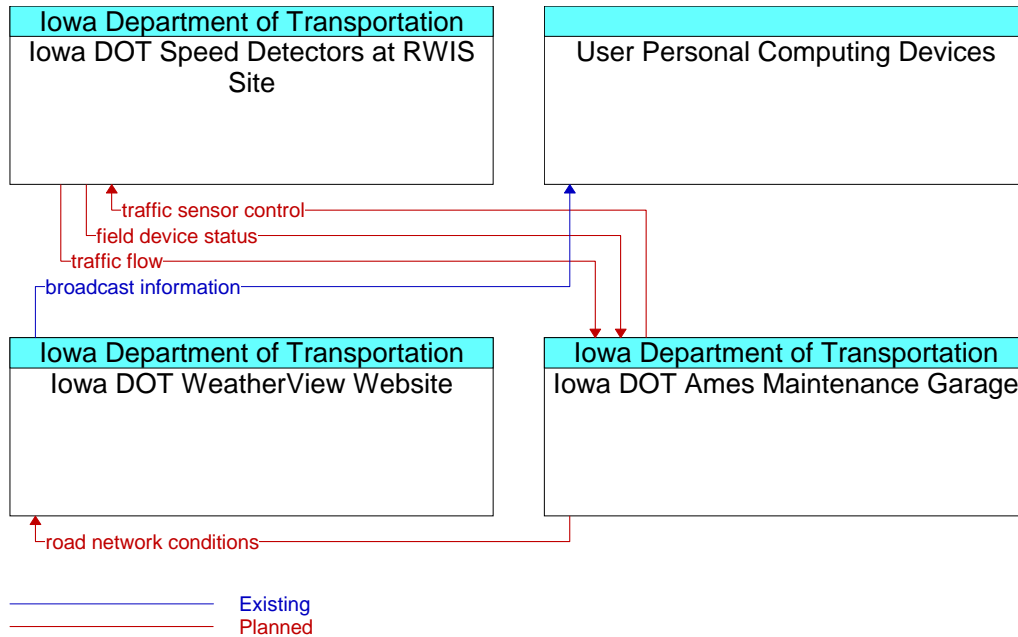

Figure 7-19. Project Architecture: Iowa DOT Speed Sensors at RWIS Site

City of Ames CyRide Transit AVL System

This project will install AVL technology to track the exact location of buses to improve operation for both Fixed Route and Moonlight Express services. The architecture flow diagram for this project is shown in Figure 7-20.

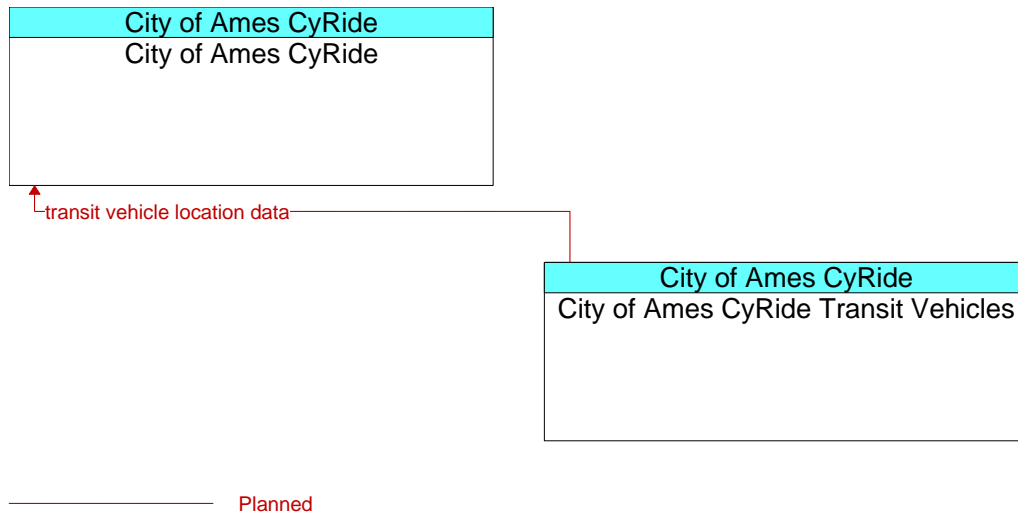

Figure 7-20. Project Architecture: City of Ames CyRide Transit AVL System

City of Ames CyRide Transit Vehicle On-board Security Cameras

This project plans to install security cameras on board of transit vehicles to provide security and safety functions. Cameras have been installed on 28 CyRide buses and additional 20 buses are planned. The architecture flow diagram for this project is shown in Figure 7-21.

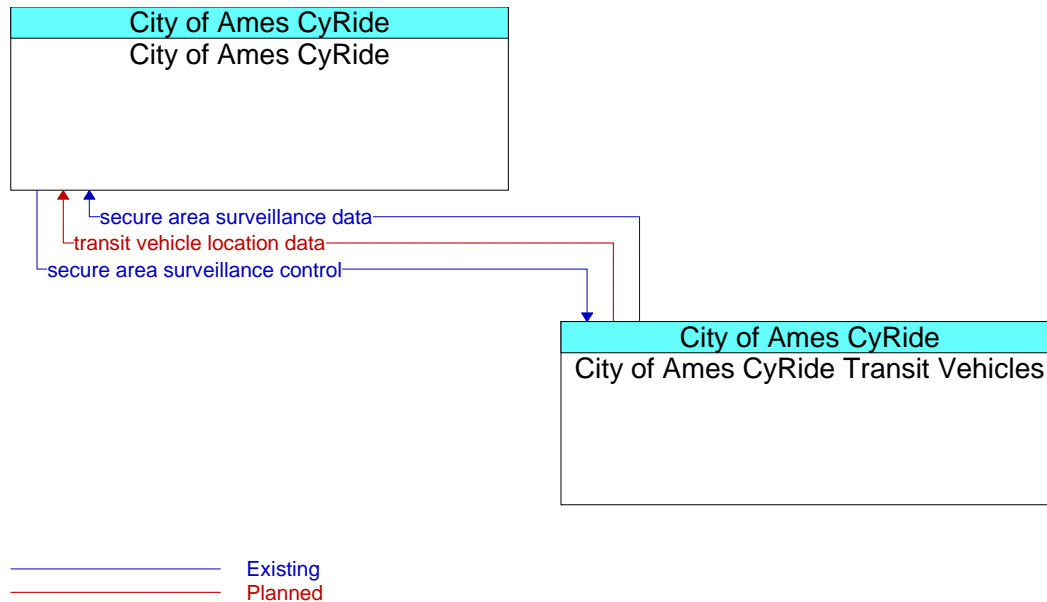

Figure 7-21. Project Architecture: City of Ames CyRide Transit Vehicle On-board Security Cameras

Consolidated 911 Computer Aided Dispatch (Story County Sheriff, City of Ames Police and Iowa State University Police)

This project will consolidate emergency communications activities between the three 911 communications centers in the region (Story County Sheriff, City of Ames Police, and Iowa State University Police). Three phases/components of deployment are planned:

- Communications Center Shared CAD and Data Network: the network allows three communications centers to seamlessly access each other's record information.
- Mapping System: the system displays the locations of emergency calls on a city/county map. This phase will install telephone switch hardware to accept location information from cellular calls, and software modules to display incidents and calls on the city/county map in the consolidated CAD and Crime Records systems.
- Mobile Data Terminals for Emergency Vehicles: the system provides field access to sheriff/police records and state and federal databases and allows direct connections to CAD information for emergency vehicles. The system will be built on the current "core technologies" in the communications centers and the TraCS system currently operating in the patrol vehicles.

The architecture flow diagram for this project is shown in Figure 7-22.

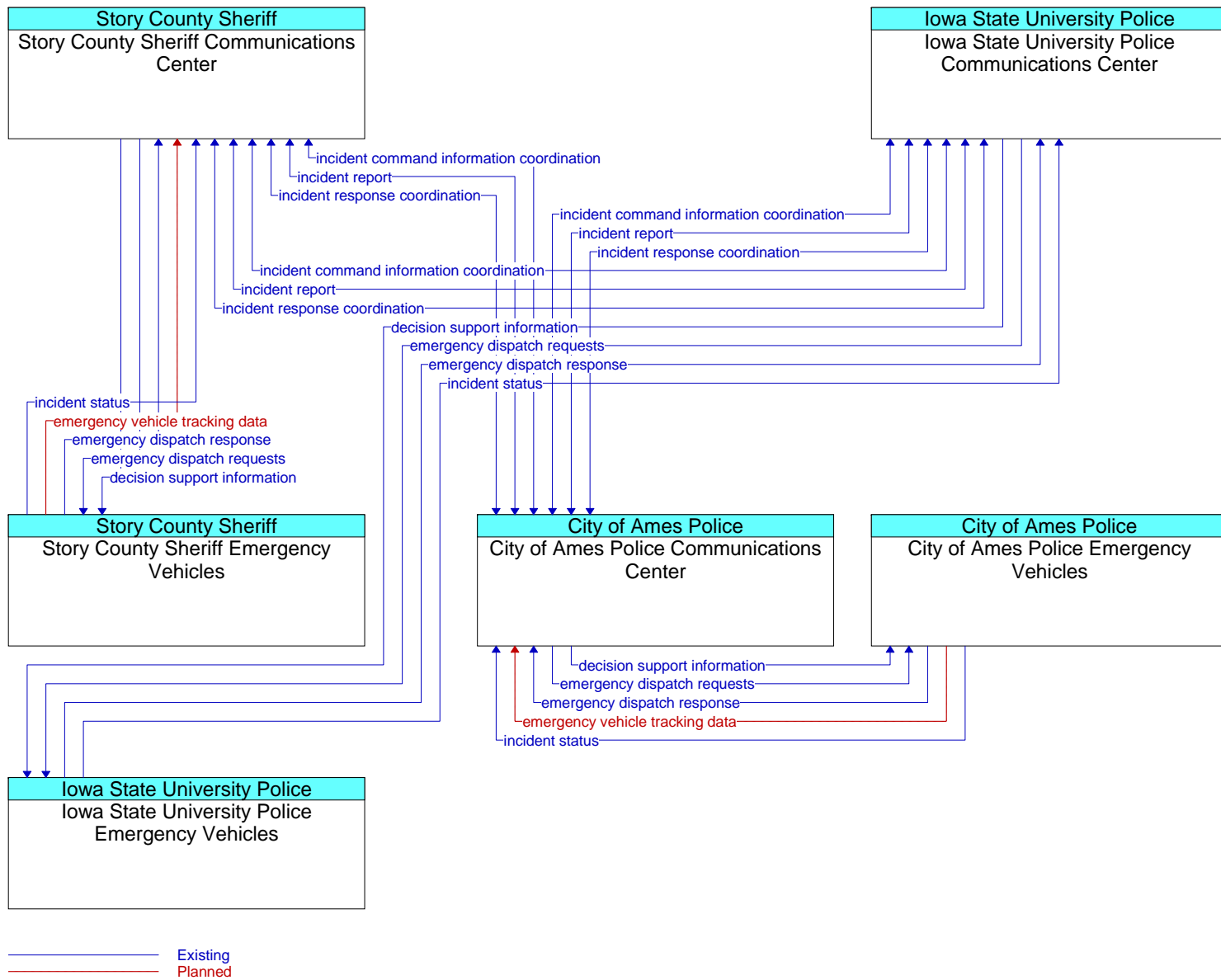

Figure 7-22. Project Architecture: Consolidated 911 Computer Aided Dispatch

8. ITS STANDARDS

ITS Standards are fundamental to the establishment of an open ITS environment that achieves the goals originally envisioned by the U.S. Department of Transportation. Standards facilitate deployment of interoperable systems at local, regional, and national levels without impeding innovation as technology advances and new approaches evolve.

Standards can be thought of as the glue that holds the various pieces of architecture together. The logical architecture presents a functional view of the ITS user services. It defines the functions or processes that are required to perform the selected ITS user services, and the information or data flows that need to be exchanged between these functions. The physical architecture partitions the functions defined by the logical architecture into systems and subsystems. To accomplish the functions outlined in the logical architecture, communication must take place between the elements of the physical architecture. Standards define how these communications take place.

8.1 Standards Benefits

Many of the benefits the public receives from the National ITS Architecture are a direct result of the development and implementation of standards. Primarily, standards provide benefits in the following areas:

- **National Compatibility** – National compatibility is represented by the ability to use the same equipment and services, regardless of the geographical location. The architecture identifies specific interfaces requiring nationwide compatibility. Examples include the delivery of real-time traveler information to in-vehicle devices and the dedicated short-range interface between the vehicle and the roadside. Nationwide standards for these types of interfaces will allow travelers and commercial vehicles to use their compliant equipment anywhere within the United States.
- **Multiple Suppliers** – The architecture can encourage competition in the delivery of ITS services through the implementation of standards in areas where a standard is not necessarily required to provide a traveler with seamless operation of his ITS service. These interfaces will benefit from standards in allowing multiple suppliers of equipment and software that will directly connect to other ITS systems.
- **Ranges of Functionality** – The standard packages contain data flows that support several levels of service. For example, the *trip plan* data flow contains a large number of optional data fields. The standards developer is encouraged to maintain the flexibility in the data flow specifications to allow for multiple implementations.
- **Synergy** – As discussed above, the architecture began with a logical architecture that satisfied the identified user services. As a result, there are functions and data flows common to several of the services. These “processes” appear in several higher-level data flows, and because they come from a single source they support synergy and consistency.
- **Risk Reduction** – The architecture reduces risk to public providers, private providers and consumers. For public providers, existence of standards means that equipment purchased one year will be likely to operate with new equipment purchased several years from now. This also means that agencies will not be locked into specific vendors since all vendors will be able to build to the same standard. For private providers, existence of standards

means that they can gather information from multiple sources using well-defined message sets and thereby increase the level of service to their customers. For consumers, products built to a particular standard will allow a user to select their service provider from a number of companies, not just the company with which their equipment happens to be compatible.

Defined standards are fundamental to the establishment of nationally compatible and interoperable ITS deployments. Standards will enable deployment of consistent, non-interfering, reliable systems on local, regional and national levels. Open standards will further benefit the consumer by enhancing competition for the range of products necessary to implement the ITS user services. Larger markets for specific products will reduce production costs through economy of scale. Producers benefit from standards because they assure a wide market over which the product can be sold. As deployment occurs, diverse systems will be developed to address the special needs of urban, suburban and rural environments. Standards must ensure interoperability across these implementations without impeding innovation as technology advances and new approaches evolve.

Well-chosen, well-timed, and broadly accepted standards can provide the following frequently referenced benefits:

- **Interoperability between diverse systems** – This benefit facilitates cost-effective area-wide implementations that ultimately provide enhanced service to the consumer.
- **Preservation of investment** – Timely standards can reduce investments in multiple incompatible approaches, some of which will become casualties of natural selection in the market place.
- **Technology insertion** – Systems can be incrementally improved to take advantage of new technologies.
- **Creation of broader markets** – Interoperability standards set the stage for national and/or international markets. The lack of a standard may ultimately limit the size of the market.
- **Interchangeability** – Interchangeable equipment reduces capital costs through increased competition and reduces maintenance costs through smaller spares inventories of less expensive replacement parts.

Note that the adopted standards must be comprehensive to support interoperability. There are several examples in which hastily developed and adopted standards have not included sufficient specification to guarantee interoperability between standard-compliant systems.

8.2 Using Standards

More than 110 standards have been identified as part of the National ITS architecture standard development activities. The task of working with public and private sector ITS community to develop these standards has been tasked to seven different standards development organizations (SDOs). These SDOs include:

- American Association of State Highway and Transportation Officials (AASHTO)
- American National Standards Institute (ANSI)
- American Society for Testing and Materials (ASTM)
- Institute of Electrical and Electronics Engineers (IEEE)
- International Organization for Standardization (ISO)
- Institute of Transportation Engineers (ITE)
- National Electrical Manufacturers Association (NEMA)
- Society of Automotive Engineers (SAE)

Information on the complete list of ITS Standards can be found on the ITS Standards webpage at <http://www.standards.its.dot.gov/>.

While the AAMPO Regional ITS Architecture is a comprehensive plan which includes various ITS applications, it does not cover every conceivable ITS technology. As such, not all ITS standards will be applicable to the existing and proposed projects. Table 8-1 summarizes the appropriate ITS standards for all existing and proposed projects within the region.

Table 8-1. Standards Supporting the AAMPO Regional ITS Projects

Standard Name	SDO	Document ID	Status*
Simple Transportation Management Framework (STMF)	AASHTO/ITE/ NEMA	NTCIP 1101	P
Octet Encoding Rules (OER) Base Protocol	AASHTO/ITE/ NEMA	NTCIP 1102	A
Transportation Management Protocols (TMP)	AASHTO/ITE/ NEMA	NTCIP 1103	A
Center-to-Center Naming Convention Specification	AASHTO/ITE/ NEMA	NTCIP 1104	A
CORBA Security Service Specification	AASHTO/ITE/ NEMA	NTCIP 1105	S
CORBA Near-Real Time Data Service Specification	AASHTO/ITE/ NEMA	NTCIP 1106	S
Global Object Definitions	AASHTO/ITE/ NEMA	NTCIP 1201	P
Object Definitions for Actuated Traffic Signal Controller Units	AASHTO/ITE/ NEMA	NTCIP 1202	P
Object Definitions for Dynamic Message Signs (DMS)	AASHTO/ITE/ NEMA	NTCIP 1203	P
Object Definitions for Environmental Sensor Station (ESS)	AASHTO/ITE/ NEMA	NTCIP 1204	P
Object Definitions for Closed Circuit Television (CCTV) Camera Control	AASHTO/ITE/ NEMA	NTCIP 1205	P
Object Definitions for Data Collection and Monitoring (DCM) Devices	AASHTO/ITE/ NEMA	NTCIP 1206	A

***Status (as of April 2006):**

P – Published: Standards that are available for purchase.

A – Approved: Standards that have passed all necessary ballots and have been approved by a standards development organization, but not yet published.

B – In Ballot: Standards that are being voted upon by a committee or working group, or are undergoing other SDO procedures.

U – Under Development: Standards that are being written, but are not yet ready for a formal ballot.

S – Standard Development Work has been suspended; or standards have been withdrawn.

Table 8-1. (Continued)

Standard Name	SDO	Document ID	Status*
Object Definitions for Closed Circuit Television (CCTV) Switching	AASHTO/ITE/ NEMA	NTCIP 1208	A
Data Element Definitions for Transportation Sensor Systems (TSS)	AASHTO/ITE/ NEMA	NTCIP 1209	A
Field Management Stations - Part 1: Object Definitions for Signal System Masters	AASHTO/ITE/ NEMA	NTCIP 1210	U
Object Definitions for Signal Control and Prioritization	AASHTO/ITE/ NEMA	NTCIP 1211	A
Weather Report Message Set for Environmental Sensor Stations	AASHTO/ITE/ NEMA	NTCIP 1301	U
TCIP Common Public Transportation (CPT) Objects	AASHTO/ITE/ NEMA	NTCIP 1401	P
TCIP Incident Management (IM) Objects	AASHTO/ITE/ NEMA	NTCIP 1402	P
TCIP Passenger Information (PI) Objects	AASHTO/ITE/ NEMA	NTCIP 1403	P
TCIP Scheduling/Runcutting (SCH) Objects	AASHTO/ITE/ NEMA	NTCIP 1404	P
TCIP Spatial Representation (SP) Objects	AASHTO/ITE/ NEMA	NTCIP 1405	P
TCIP On-Board (OB) Objects	AASHTO/ITE/ NEMA	NTCIP 1406	P
TCIP Control Center (CC) Objects	AASHTO/ITE/ NEMA	NTCIP 1407	P
TCIP Fare Collection (FC) Business Area Objects	AASHTO/ITE/ NEMA	NTCIP 1408	P
Point to Multi-Point Protocol Using RS-232 Subnetwork Profile	AASHTO/ITE/ NEMA	NTCIP 2101	P
Point to Multi-Point Protocol Using FSK Modem Subnetwork Profile	AASHTO/ITE/ NEMA	NTCIP 2102	P
Point-to-Point Protocol Over RS-232 Subnetwork Profile	AASHTO/ITE/ NEMA	NTCIP 2103	P
Ethernet Subnetwork Profile	AASHTO/ITE/ NEMA	NTCIP 2104	P
Transportation Transport Profile	AASHTO/ITE/ NEMA	NTCIP 2201	P
Internet (TCP/IP and UDP/IP) Transport Profile	AASHTO/ITE/ NEMA	NTCIP 2202	P
Simple Transportation Management Framework (STMF) Application Profile	AASHTO/ITE/ NEMA	NTCIP 2301	P
Trivial File Transfer Protocol (TFTP) Application Profile	AASHTO/ITE/ NEMA	NTCIP 2302	P
File Transfer Protocol (FTP) Application Profile	AASHTO/ITE/ NEMA	NTCIP 2303	P

***Status (as of April 2006):**

P – Published: Standards that are available for purchase.

A – Approved: Standards that have passed all necessary ballots and have been approved by a standards development organization, but not yet published.

B – In Ballot: Standards that are being voted upon by a committee or working group, or are undergoing other SDO procedures.

U – Under Development: Standards that are being written, but are not yet ready for a formal ballot.

S – Standard Development Work has been suspended; or standards have been withdrawn.

Table 8-1. (Continued)

Standard Name	SDO	Document ID	Status*
Application Profile for DATEX-ASN (AP-DATEX)	AASHTO/ITE/ NEMA	NTCIP 2304	P
Application Profile for CORBA (AP-CORBA)	AASHTO/ITE/ NEMA	NTCIP 2305	S
Application Profile for XML Message Encoding and Transport in ITS C2C Communications	AASHTO/ITE/ NEMA	NTCIP 2306	U
Information Profile for DATEX	AASHTO/ITE/ NEMA	NTCIP 2501	S
Information Profile for CORBA	AASHTO/ITE/ NEMA	NTCIP 2502	S
Commercial Vehicle Safety and Credentials Information Exchange	ANSI	ANSI TS285	P
Commercial Vehicle Credentials	ANSI	ANSI TS286	P
Transit Communications Interface Profile	APTA	TCIP Dialogs	U
Standard Specification for Dedicated Short Range Communication (DSRC) Physical Layer using Microwave in the 902-928 MHz Band	ASTM	ASTM E2158-01	P
Standard Specification for Telecommunications and Information Exchange Between Roadside and Vehicle Systems - 5 GHz Band Dedicated Short Range Communications (DSRC) Medium Access Control (MAC) and Physical Layer (PHY) Specifications	ASTM	ASTM E2213-03	P
Standard Practice for Metadata to Support Archived Data Management Systems	ASTM	ASTM E2468-05	P
Standard Specification for Archiving ITS Generated Traffic Monitoring Data	ASTM	ASTM WK7604	U
Standard Provisional Specification for Dedicated Short Range Communication (DSRC) Data Link Layer	ASTM	ASTM PS 105-99	S
Logical Link (Layer 2) for DSRC 5.9 GHz	IEEE	IEEE 802.2	P
Standard for Message Sets for Vehicle/Roadside Communications	IEEE	IEEE 1455-1999	P
Standard for Common Incident Management Message Sets (IMMS) for use by EMCs	IEEE	IEEE 1512-2000	P
Standard for Traffic Incident Management Message Sets for Use by EMCs	IEEE	IEEE 1512.1-2003	P
Standard for Public Safety IMMS for use by EMCs	IEEE	IEEE 1512.2-2004	P
Standard for Hazardous Material IMMS for use by EMCs	IEEE	IEEE 1512.3-2002	P
Standard for Common Traffic Incident Management Message Sets for Use in Entities External to Centers	IEEE	IEEE P1512.4	U
Standard for Security and Privacy of Vehicle/Roadside Communication Including Smart Card Communication	IEEE	IEEE 1556	U
Standard for Interface Between the Rail Subsystem and the Highway Subsystem at a Highway Rail Intersection	IEEE	IEEE 1570-2002	P

***Status (as of April 2006):**

P – Published: Standards that are available for purchase.

A – Approved: Standards that have passed all necessary ballots and have been approved by a standards development organization, but not yet published.

B – In Ballot: Standards that are being voted upon by a committee or working group, or are undergoing other SDO procedures.

U – Under Development: Standards that are being written, but are not yet ready for a formal ballot.

S – Standard Development Work has been suspended; or standards have been withdrawn.

Table 8-1. (Continued)

Standard Name	SDO	Document ID	Status*
Standard for Wireless Access in Vehicular Environments (WAVE) – Resource Manager	IEEE	IEEE P1609.1	B
Standard for Wireless Access in Vehicular Environments (WAVE) – Security Services for Applications & Management Messages	IEEE	IEEE P1609.2	B
Standard for Wireless Access in Vehicular Environments (WAVE) – Networking Services	IEEE	IEEE P1609.3	B
Standard for Wireless Access in Vehicular Environments (WAVE) – Multi-Channel Operation	IEEE	IEEE P1609.4	B
Networking Services (Layer 3) for DSRC 5.9 GHz	ISO	ISO 21210	U
Standard for Functional Level Traffic Management Data Dictionary (TMDD)	ITE	ITE TM 1.03	A
Message Sets for External TMC Communication (MS/ETMCC)	ITE	ITE TM 2.01	A
Location Referencing Message Specification(LRMS)	SAE	SAE J2266	P
Data Dictionary for Advanced Traveler Information Systems (ATIS)	SAE	SAE J2353	P
Message Set for Advanced Traveler Information System (ATIS)	SAE	SAE J2354	P
Standard for ATIS Message Sets Delivered Over Reduced Bandwidth Media	SAE	SAE J2369	P
Rules for Standardizing Street Names and Route IDs	SAE	SAE J2529	A
Messages for Handling Strings and Look-Up Tables in ATIS Standards	SAE	SAE J2540	P
RDS (Radio Data System) Phrase Lists	SAE	SAE J2540-1	P
ITIS (International Traveler Information Systems) Phrase Lists	SAE	SAE J2540-2	P
National Names Phrase List	SAE	SAE J2540-3	P

***Status (as of April 2006):**

P – Published: Standards that are available for purchase.

A – Approved: Standards that have passed all necessary ballots and have been approved by a standards development organization, but not yet published.

B – In Ballot: Standards that are being voted upon by a committee or working group, or are undergoing other SDO procedures.

U – Under Development: Standards that are being written, but are not yet ready for a formal ballot.

S – Standard Development Work has been suspended; or standards have been withdrawn.

8.3 Mapping of Recommended Standards to Application Areas

Table 8-2 provided a guide to the recommended ITS standards that should be considered for use in different types of ITS projects within the region. Each row in the table represents an ITS standard and each column represents one of nineteen application areas. The standards included in the table are those that relate to the subsystems and information flows between them that are likely to be included in the ITS projects within the region. The application areas are deployment-oriented categories that focus on specific ITS services or systems. Each application area consists of one or more interfaces in the National ITS Architecture. They were chosen so that agencies and service providers can easily find the application area within which a particular ITS project fits. Most ITS projects will relate to only one application area, although larger projects may relate to more than one application area.

Note that not all interfaces in the AAMPO Regional ITS Architecture are represented by an application area. This is because not all interfaces are currently represented by an approved or published ITS standards. Additional application areas may be added in the future as additional ITS standards become available. The inclusion of a standard in an application area indicates that that standard may apply—not that it must apply. On the other hand, the exclusion of a standard from an application area does not mean that the standard may not be used in a project for that application area. For example, traffic management standards do not include traveler information standards; however, traffic management centers may benefit from knowing what traveler information systems do with the information.

Table 8-2. Key ITS Standards Application Area Matrix for AAMPO Region

SDO	Doc ID	Standard Name	Center to Center							Center to Roadside							Center to Vehicle/Traveler		Roadside to Roadside	Roadside to Vehicle
			Data Archival	Incident Management	Rail Coordination	Traffic Management	Transit Management	Traveler Information	Data Collection/Monitoring	Dynamic Message Signs	Environmental Monitoring	Ramp Metering	Traffic Signals	Vehicle Sensors	Video Surveillance	Mayday	Transit Vehicle Communications	Traveler Information	Highway Rail Intersection (HRI)	Signal Priority
AASHTO	1101	Simple Transportation Management Framework (STMF)																		
AASHTO	1102	Octet Encoding Rules (OER) Base Protocol	●	●	●	●	●	●	●	●	●	●	●	●	●					
AASHTO	1103	Transportation Management Protocols (TMP)						●	●	●	●	●	●							
AASHTO	1104	Center-to-Center Naming Convention Specification	●	●	●	●	●	●												
AASHTO	1105	CORBA Security Service Specification	●	●	●	●	●	●												
AASHTO	1106	CORBA Near-Real Time Data Service Specification	●	●	●	●	●	●												
AASHTO	1201	Global Object Definitions		●				●	●	●	●	●	●					●		
AASHTO	1202	Object Definitions for Actuated Traffic Signal Controller Units									●									
AASHTO	1203	Object Definitions for Dynamic Message Signs (DMS)							●											
AASHTO	1204	Object Definitions for Environmental Sensor Station (ESS)						●		●										
AASHTO	1205	Object Definitions for Closed Circuit Television (CCTV) Camera Control						●				●	●							

SDO	Doc ID	Standard Name	Center to Center						Center to Roadside						Center to Vehicle/Traveler		Roadside to Roadside	Roadside to Vehicle		
			Data Archival	Incident Management	Rail Coordination	Traffic Management	Transit Management	Traveler Information	Data Collection/Monitoring	Dynamic Message Signs	Environmental Monitoring	Ramp Metering	Traffic Signals	Vehicle Sensors	Video Surveillance	Mayday	Transit Vehicle Communications	Traveler Information	Highway Rail Intersection (HRI)	Signal Priority
AASHTO	1206	Object Definitions for Data Collection and Monitoring (DCM) Devices							●		●									
AASHTO	1208	Object Definitions for Closed Circuit Television (CCTV) Switching							●											
AASHTO	1209	Data Element Definitions for Transportation Sensor Systems (TSS)							●		●	●	●							
AASHTO	1210	Field Management Stations - Part 1: Object Definitions for Signal System Masters				●					●									
AASHTO	1211	Object Definitions for Signal Control and Prioritization		●																●
AASHTO	1301	Weather Report Message Set for Environmental Sensor Stations								●										
AASHTO	1401	TCIP Common Public Transportation (CPT) Objects	●								●									
AASHTO	1402	TCIP Incident Management (IM) Objects	●	●											●		●			
AASHTO	1403	TCIP Passenger Information (PI) Objects	●								●						●			
AASHTO	1404	TCIP Scheduling/Runcutting (SCH) Objects	●								●						●			
AASHTO	1405	TCIP Spatial Representation (SP) Objects	●								●						●			
AASHTO	1406	TCIP On-Board (OB) Objects	●												●		●			

SDO	Doc ID	Standard Name	Center to Center							Center to Roadside							Center to Vehicle/Traveler	Roadside to Roadside	Roadside to Vehicle
			Data Archival	Incident Management	Rail Coordination	Traffic Management	Transit Management	Traveler Information	Data Collection/Monitoring	Dynamic Message Signs	Environmental Monitoring	Ramp Metering	Traffic Signals	Vehicle Sensors	Video Surveillance	Mayday	Transit Vehicle Communications	Traveler Information	Highway Rail Intersection (HRI)
AASHTO	1407	TCIP Control Center (CC) Objects	●				●							●	●				
AASHTO	1408	TCIP Fare Collection (FC) Business Area Objects	●				●								●	●			
AASHTO	2101	Point to Multi-Point Protocol Using RS-232 Subnetwork Profile						●	●	●	●	●	●						
AASHTO	2102	Point to Multi-Point Protocol Using FSK Modem Subnetwork Profile						●	●	●	●	●	●						
AASHTO	2103	Point-to-Point Protocol Over RS-232 Subnetwork Profile						●	●	●	●	●	●						
AASHTO	2104	Ethernet Subnetwork Profile	●	●	●	●	●	●	●	●	●	●	●						
AASHTO	2201	Transportation Transport Profile						●	●	●	●	●	●						
AASHTO	2202	Internet (TCP/IP and UDP/IP) Transport Profile	●	●	●	●	●	●	●	●	●	●	●						
AASHTO	2301	Simple Transportation Management Framework (STMF) Application Profile						●	●	●	●	●	●						
AASHTO	2302	Trivial File Transfer Protocol (TFTP) Application Profile						●	●	●		●	●						
AASHTO	2303	File Transfer Protocol (FTP) Application Profile	●	●	●	●	●	●	●			●	●						
AASHTO	2304	Application Profile for DATEX-ASN (AP-DATEX)	●	●	●	●	●												
AASHTO	2305	Application Profile for CORBA (AP-CORBA)	●	●	●	●	●												

SDO	Doc ID	Standard Name	Center to Center						Center to Roadside						Center to Vehicle/Traveler	Roadside to Roadside	Roadside to Vehicle			
			Data Archival	Incident Management	Rail Coordination	Traffic Management	Transit Management	Traveler Information	Data Collection/Monitoring	Dynamic Message Signs	Environmental Monitoring	Ramp Metering	Traffic Signals	Vehicle Sensors	Video Surveillance	Mayday	Transit Vehicle Communications	Traveler Information	Highway Rail Intersection (HRI)	Signal Priority
AASHTO	2306	Application Profile for XML Message Encoding and Transport in ITS C2C Communications	●	●	●	●	●	●												
AASHTO	2501	Information Profile for DATEX	●	●	●	●	●	●												
AASHTO	2502	Information Profile for CORBA	●	●	●	●	●	●												
ANSI	TS285	Commercial Vehicle Safety and Credentials Information Exchange	●																	
ANSI	TS286	Commercial Vehicle Credentials	●																	
APTA	TCIP Dialogs	Transit Communications Interface Profile		●			●							●	●	●				
ASTM	E2158-01	Standard Specification for Dedicated Short Range Communication (DSRC) Physical Layer using Microwave in the 902-928 MHz Band																	●	●
ASTM	E2213-03	Standard Specification for Telecommunications and Information Exchange Between Roadside and Vehicle Systems - 5 GHz Band Dedicated Short Range Communications (DSRC) Medium Access Control (MAC) and Physical Layer (PHY) Specifications																	●	●

SDO	Doc ID	Standard Name	Center to Center						Center to Roadside						Center to Vehicle/Traveler		Roadside to Roadside	Roadside to Vehicle	
			Data Archival	Incident Management	Rail Coordination	Traffic Management	Transit Management	Traveler Information	Data Collection/Monitoring	Dynamic Message Signs	Environmental Monitoring	Ramp Metering	Traffic Signals	Vehicle Sensors	Video Surveillance	Mayday	Transit Vehicle Communications	Traveler Information	Highway Rail Intersection (HRI)
ASTM	E2468-05	Standard Practice for Metadata to Support Archived Data Management Systems	●																
ASTM	WK7604	Standard Specification for Archiving ITS Generated Traffic Monitoring Data	●																
ASTM	PS 105-99	Standard Provisional Specification for Dedicated Short Range Communication (DSRC) Data Link Layer																●	
IEEE	802.2	Logical Link (Layer 2) for DSRC 5.9 GHz																●	●
IEEE	1455-1999	Standard for Message Sets for Vehicle/Roadside Communications																	●
IEEE	1512-2000	Standard for Common Incident Management Message Sets (IMMS) for use by EMCs	●	●															
IEEE	1512.1-2003	Standard for Traffic Incident Management Message Sets for Use by EMCs	●	●	●														
IEEE	1512.2-2004	Standard for Public Safety IMMS for use by EMCs	●	●															
IEEE	1512.3-2002	Standard for Hazardous Material IMMS for use by EMCs	●	●															

SDO	Doc ID	Standard Name	Center to Center						Center to Roadside						Center to Vehicle/Traveler		Roadside to Roadside	Roadside to Vehicle	
			Data Archival	Incident Management	Rail Coordination	Traffic Management	Transit Management	Traveler Information	Data Collection/Monitoring	Dynamic Message Signs	Environmental Monitoring	Ramp Metering	Traffic Signals	Vehicle Sensors	Video Surveillance	Mayday	Transit Vehicle Communications	Traveler Information	Highway Rail Intersection (HRI)
IEEE	P1512.4	Standard for Common Traffic Incident Management Message Sets for Use in Entities External to Centers	●	●															
IEEE	1556	Standard for Security and Privacy of Vehicle/Roadside Communication Including Smart Card Communication																	●
IEEE	1570-2002	Standard for Interface Between the Rail Subsystem and the Highway Subsystem at a Highway Rail Intersection															●		
IEEE	P1609.1	Standard for Wireless Access in Vehicular Environments (WAVE) – Resource Manager																●	●
IEEE	P1609.2	Standard for Wireless Access in Vehicular Environments (WAVE) – Security Services for Applications & Management Messages																●	●
IEEE	P1609.3	Standard for Wireless Access in Vehicular Environments (WAVE) – Networking Services																●	●
IEEE	P1609.4	Standard for Wireless Access in Vehicular Environments (WAVE) – Multi-Channel Operations																●	●
ISO	21210	Networking Services (Layer 3) for DSRC 5.9 GHz																●	●

SDO	Doc ID	Standard Name	Center to Center						Center to Roadside						Center to Vehicle/Traveler	Roadside to Roadside	Roadside to Vehicle		
			Data Archival	Incident Management	Rail Coordination	Traffic Management	Transit Management	Traveler Information	Data Collection/Monitoring	Dynamic Message Signs	Environmental Monitoring	Ramp Metering	Traffic Signals	Vehicle Sensors	Video Surveillance	Mayday	Transit Vehicle Communications	Traveler Information	Highway Rail Intersection (HRI)
ITE	TM 1.03	Standard for Functional Level Traffic Management Data Dictionary (TMDD)	●	●		●	●												
ITE	TM 2.01	Message Sets for External TMC Communication (MS/ETMCC)	●	●		●	●												
SAE	J2266	Location Referencing Message Specification (LRMS)	●	●	●	●	●	●	●	●	●	●	●	●	●	●			
SAE	J2353	Data Dictionary for Advanced Traveler Information System (ATIS)	●			●	●	●						●	●	●			
SAE	J2354	Message Set for Advanced Traveler Information System (ATIS)	●			●	●	●						●	●	●			
SAE	J2369	Standard for ATIS Message Sets Delivered Over Reduced Bandwidth Media														●			
SAE	J2529	Rules for Standardizing Street Names and Route IDs	●			●	●	●						●	●	●			
SAE	J2540	Messages for Handling Strings and Look-Up Tables in ATIS Standards	●			●	●	●						●	●	●			
SAE	J2540-1	RDS (Radio Data System) Phrase Lists	●			●	●	●						●	●	●			
SAE	J2540-2	ITIS (International Traveler Information Systems) Phrase Lists	●			●	●	●						●	●	●			
SAE	J2540-3	National Names Phrase List	●			●	●	●						●	●	●			

9. PROJECT SEQUENCING

A project sequence defines the order in which ITS projects may be implemented. A good sequence is based on a combination of two factors:

- **Prioritization of projects based on existing conditions and stakeholder needs.** The regional ITS projects were prioritized to reflect a deployment path (sequence) on stakeholder needs. Although the information collected through stakeholder surveys and meetings was the basis of the regional ITS architecture, technology, funding opportunities and requirements continue to evolve. It is expected that the stakeholders from throughout the region will reevaluate and reprioritize projects frequently.
- **Project dependencies, based on how successive ITS projects can build upon one another.** Project dependencies influence the project sequencing. It is beneficial to identify the information and functional dependencies between projects based on the regional ITS architecture and any other external dependencies that affect the project sequence.

When possible, ITS system components will be deployed in conjunction with major construction activities along the corridor to minimize cost and disruption to traffic. In some cases, the hardware component will be installed in advance of a fully functional system. An example would be in-pavement loop detectors. The cost of deploying a loop detector during construction is much lower than cutting a loop detector into an existing roadway.

In most cases, the sequence of currently planned projects has already been programmed and can simply be extracted from existing transportation plans. Successive projects will then be added to the sequence based on the project dependencies and other planning factors.

The process for determining the sequence of projects for the AAMPO Regional ITS Architecture includes two steps:

- Review of relevant planning documents
- Stakeholder feedback

The AAMPO Regional ITS Architecture represents a roadmap for transportation systems deployment and integration within the region over the next 10 years. A list of ITS projects that have currently been planned over the next 10 years was identified in Table 9-1. Through the above process, the recommended ITS project sequencing was determined. The list was further refined to establish which projects were allocated to the short term (within 3 years), medium term (4 to 6 years), and long term (over 7 years). This provided a priority for the list of projects denoting a general order for project implementation. A list of such projects is presented in Table 9-2.

Table 9-1. Planned ITS Projects for AAMPO Regional ITS Architecture

*Note: Timeframe - Short Term: 0-3 years; Medium Term: 4-6 years; Long Term: beyond 6 years.

Project	Description	Timeframe*	Dependency
Iowa DOT CCTV Camera on RWIS Tower	One camera will be installed on the existing RWIS tower. The camera can provide images of the roadway that can be used by maintenance managers and the traveling public to observe the condition of the road and traffic flow. WeatherView will be upgraded to include camera information.	Short	Stand alone. However, the project may be deployed in conjunction with Precipitation and Visibility Sensors.
Iowa DOT Precipitation and Visibility Sensors	Update existing yes/no sensors to optical weather identifiers and visibility detectors or other accurate, versatile precipitation identification equipment. Improved precipitation observations will help maintenance managers and forecasters track the path and characteristics of precipitation. Visibility detection performance will be tested to determine if the observations can be used as a guide for road closures.	Short	Stand alone. However, this project may be deployed in conjunction with CCTV Camera on RWIS Tower.
Iowa DOT Speed Detectors at RWIS site	Install speed detectors near or on the existing RWIS site. Speed information can be used to assess winter maintenance performance, the effects of certain weather events on traffic flow, and monitor the current traffic flow for the traveling public. The WeatherView website will be upgraded to include speed information.	Short	Stand alone. However, this project could be deployed in conjunction with CCTV Camera on RWIS Tower and/or Precipitation and Visibility Sensors.
Iowa DOT Permanent DMS	A permanent DMS is planned on I-35 south of US 30 for northbound traffic in 2006. The DMS will be used to alert travelers to changing road conditions and other events such as Amber Alerts and homeland security.	Short	Stand alone.
Iowa DOT Iowa State University Special Events Study	Special event traffic studies and ITS deployment for recurring special events at Iowa State University. The project includes traffic data collection, preliminary engineering, planning, coordination, archival and deployment of ITS devices.	Short	Stand alone.

Project	Description	Timeframe*	Dependency
Consolidated 911 Computer Aided Dispatch	<p>Consolidate emergency communications activities between the three 911 communications centers in the region (Story County Sheriff, City of Ames Police, and Iowa State University Police). Three phases/components of deployment are planned:</p> <ul style="list-style-type: none"> • Communications Center Shared CAD and Data Network: the network allows three communications centers to seamlessly access each other's record information. • Mapping System: the system displays the locations of emergency calls on a city/county map. This phase will install telephone switch hardware to accept location information from cellular calls, and software modules to display incidents and calls on the city/county map in the consolidated CAD and Crime Records systems. • Mobile Data Terminals for Emergency Vehicles: the system provides field access to sheriff/police records and state and federal databases and allows direct connections to CAD information for emergency vehicles. The system will be built on the current "core technologies" in the communications centers and the TraCS system currently operating in the patrol vehicles. 	Short	Stand alone.

Project	Description	Timeframe*	Dependency
City of Ames Police Computer Aided Dispatch Hardware Consolidation	The updated hardware supports operations of the emergency communications center by providing a record of incidents, location history, property information and the status of all emergency units in the field. When Consolidated 911 CAD Dispatch between three 911 communications centers (Story County Sheriff, City of Ames Police and Iowa State University Police) is completed, the records would be combined with those of Story County Sheriff and Iowa State University Police and be shared with each other.	Short	Stand alone. However, this project could be deployed in conjunction with Consolidated 911 Computer Aided Dispatch.
Mary Greeley Medical Center Dispatch Upgrade	An integrated dispatch system with Emergency Medical Dispatch and wireless technology between dispatch and the ambulances.	Short	Stand alone.
Story County Engineer Automated Vehicle Maintenance Scheduling System	Automate vehicle maintenance scheduling based on vehicle and equipment condition and availability.	Short/Medium	Stand alone.
City of Ames CyRide RouteMatch Software	Install RouteMatch software to support scheduling, dispatch operations, billing and report.	Short/Medium	Stand alone. However, this project could be deployed in conjunction with CyRide AVL/GPS System.
City of Ames CyRide AVL System	Install AVL technology to track the exact location of buses to improve operation of both Fixed Route and Moonlight Express.	Short/Medium	Stand alone. However, this project could be deployed in conjunction with CyRide RouteMatch Software.
City of Ames CyRide Transit Vehicle On-board Security Cameras	Security cameras have been installed in some buses and additional ones are planned.	Short/Medium	Stand alone.
City of Ames RWIS	RWIS are planned along major city roadways to monitor road weather conditions, including bridge and pavement surface temperature, air temperature, wind speeds and direction, humidity, etc.	Medium/Long	Stand alone.

Project	Description	Timeframe*	Dependency
City of Ames Roadway Anti-Icing System	The systems use sensors to identify icy conditions, and release liquid chemicals onto roadways/bridges.	Medium/Long	Stand alone.
City of Ames CyRide Automated Vehicle Maintenance Scheduling System	Automate vehicle maintenance scheduling based on vehicle and equipment condition and availability.	Medium/Long	Stand alone.
City of Ames Traffic Information Website	Plan to disseminate real-time traffic information through website.	Medium/Long	Stand alone.
City of Ames CyRide Transit Information Website	Provide real-time transit information and support trip planning.	Medium/Long	Stand alone. Implementation of AVL/GPS System will provide real-time transit location information to this project.
City of Ames CyRide Transit Signal Priority	Have the capability to receive priority lights at signalized intersections.	Medium/Long	Stand alone.
City of Ames CyRide Transit Stop Electronic Displays/Audio Announcements	Provide real-time transit information via electronic displays/audio announcement equipment at bus stops.	Medium/Long	Stand alone.

10. AGREEMENTS

The AAMPO Regional ITS Architecture provides both a technical and institutional framework for the deployment of ITS in the AAMPO region. Institutional integration involves cooperation and coordination between various agencies and jurisdictions to achieve seamless operations and interoperability.

The previous sections of the report identified the stakeholder roles and responsibilities, key market packages, and ITS deployment activities that would require establishment of an electronic link between and among organizations. From an institutional integration perspective, these electronic links or interfaces will require the establishment of some form of agreement to define roles and responsibilities of each party.

There are several types of arrangements associated with the interfaces identified in the AAMPO Regional ITS Architecture. Information sharing and exchanges between systems require agreements on the transmission protocol and data formats to ensure compatibility. Coordinating field device operations owned by different agencies requires defined procedures for submitting message requests and rules governing when such requests can be honored. Such coordination can be done with informal arrangements such as a Memorandum of Understanding (MOU). Sharing control of field devices operated by different agencies involves more liability issues, which requires more formal agreements. Coordinated incident response may also require formal agreements, but also requires group training of personnel from various agencies. While all interfaces involve agreements for data compatibility, agreements for procedure, operation, and maintenance as well as training can also be critical elements to optimizing the benefits of the architecture.

There is considerable variation between ITS projects and among stakeholders regarding the types of agreements that are created to support ITS integration. Some common types of agreements provided are listed in Table 10-1. The agreement process may begin with something as simple as a handshake agreement. But, once interconnections and integration of systems begin, agencies may want to have something more substantial in place. A documented agreement will aid agencies in planning their operational costs, understanding their respective roles and responsibilities and build trust for future projects. Formal agreements are necessary where funding or financial arrangements are defined or participation in large regionally significant projects is required.

Table 10-2 presents a list of existing and potential agreements that would be required for the implementation and operations of an integrated ITS system within the AAMPO region.

Table 10-1. Types of Agreements

Type of Agreement	Description
Handshake Agreement	<ul style="list-style-type: none"> ▪ Early agreement between one or more partners ▪ Not recommended for long term operations.
Memorandum of Understanding (MOU)	<ul style="list-style-type: none"> ▪ Initial agreement used to provide minimal detail and usually demonstrating a general consensus. ▪ Used to expand a more detailed agreement like an Interagency Agreement that may be broad in scope but contains all of the standard contract clauses required by a specific agency. ▪ May serve as a means to modify a much broader Master Funding Agreement, allowing the master agreement to cover various ITS projects throughout the region and the MOUs to specify the scope and differences between the projects.
Interagency Agreement	<ul style="list-style-type: none"> ▪ Between public agencies (i.e., transit authorities, cities, counties, etc.) for operations, services or funding ▪ Documents responsibility, functions and liability at a minimum.
Intergovernmental Agreement	<ul style="list-style-type: none"> ▪ Between governmental agencies (i.e., Agreements between universities and State DOT, MPOs and State DOT, etc.)
Operational Agreement	<ul style="list-style-type: none"> ▪ Between any agency involved in funding, operating, maintaining or using the right of way of another public or private agency. ▪ Identifies respective responsibilities for all activities associated with shared systems being operated and / or maintained.
Funding Agreement	<ul style="list-style-type: none"> ▪ Documents the funding arrangements for ITS projects (and other projects) ▪ Includes at a minimum standard funding clauses, detailed scope, services to be performed, detailed project budgets, etc.
Master Agreements	<ul style="list-style-type: none"> ▪ Standard contract and / or legal verbiage for a specific agency and serving as a master agreement by which all business is done. These agreements can be found in the legal department of many public agencies. ▪ Allows states, cities, transit agencies and other public agencies that do business with the same agencies over and over (i.e., cities and counties) to have one Master Agreement that uses smaller agreements (i.e., MOUs, Scope of Work and Budget Modifications, Funding Agreements, Project Agreements, etc.) to modify or expand the boundaries of the larger agreement to include more specific language.

Table 10-2. AAMPO Regional ITS Architecture Existing/Potential Agreements

Agreement	Description	Associated Stakeholder	Status
Inter-Agency Data Sharing Agreement	Formal agreements are required to cover the exchange of data between different agencies in different regions. However, informally, the exchange of information may occur on an as-needed basis. Data may include traffic flow, video images, road weather, road conditions, etc.	Iowa DOT, Iowa State Patrol, City of Ames Police, City of Ames Fire, Boone County Emergency Management Agency, Boone County Sheriff, Story County Emergency Management, Story County Sheriff, Iowa State University Police, Mary Greeley Medical Center, Nevada Fire Department, Westory Fire Agency, City of Ames Public Works, Boone County Engineer, Story County Engineers, Union Pacific Railroad, AAMPO, City of Ames Fleet Services, Iowa State University Facilities Utility Services	Existing/ Planned
Inter-Agency Operations Agreement	Address equipment operation coordination, equipment maintenance, operational information exchange and other issues. Equipment may include traffic signal systems, DMS, CCTV, etc.	Iowa DOT, Iowa State Patrol, City of Ames Public Works, Story County Engineers, Boone County Engineer, City of Ames Police, Story County Sheriff	Existing/ Planned
Multi-Agency Communication Infrastructure Sharing Agreement	There are multiple examples and opportunities for the sharing of communications infrastructure throughout the regions. A regional plan and subsequent agreements that define responsibilities could result in the communications network required to link the various ITS applications together.	Iowa DOT, Iowa State Patrol, City of Ames Police, City of Ames Fire, Boone County Emergency Management Agency, Boone County Sheriff, Story County Emergency Management, Story County Sheriff, Iowa State University Police, Mary Greeley Medical Center, Nevada Fire Department, Westory Fire Agency, City of Ames Public Works, Boone County Engineer, Story County Engineers	Planned
Inter-Agency Road Maintenance/Snow Removal Agreement	Define roles and responsibilities for roadway maintenance as well as snow removal.	Iowa DOT, City of Ames Public Works, Story County Engineers, Boone County Engineer, Iowa State University Facilities Service	Existing

Agreement	Description	Associated Stakeholder	Status
Multi-Agency EMS Communications Integration Agreement	Integrated EMS communications allows for quickly sharing of current incident response status between allied response agencies and creates a flow of information that reduces or eliminates delay due to a lag in communications.	Story County Sheriff, City of Ames Police, Iowa State University Police	Planned
Multi-Agency Incident Response Coordination Agreement	Support incident information exchange, incident response coordination, resource coordination, etc. among multiple agencies in different regions.	Iowa DOT, Iowa State Patrol, City of Ames Police, City of Ames Fire, Boone County Emergency Management Agency, Boone County Sheriff, Story County Emergency Management, Story County Sheriff, Iowa State University Police, Mary Greeley Medical Center, Nevada Fire Department, Westory Fire Agency, Ames Municipal Airport, City of Ames Public Works, Boone County Engineer, Story County Engineers, City of Ames CyRide, Heartland Senior Services, Boone County Transportation, Iowa State University Facilities Service	Existing/ Planned
Multi-Agency Disaster Response Coordination Agreement	Define roles, responsibilities, and functions for disaster response, recovery and evacuation and reentry management.	Iowa DOT, Iowa State Patrol, City of Ames Police, City of Ames Fire, Boone County Emergency Management Agency, Boone County Sheriff, Story County Emergency Management, Story County Sheriff, Iowa State University Police, Mary Greeley Medical Center, Nevada Fire Department, Westory Fire Agency, Ames Municipal Airport, City of Ames Public Works, Boone County Engineer, Story County Engineers, City of Ames CyRide, Heartland Senior Services, Boone County Transportation, Iowa State University Facilities Service	Existing/ Planned

Agreement	Description	Associated Stakeholder	Status
Multi-Agency Disaster Information Coordination Agreement	Define roles, responsibilities and functions for accessing and disseminating disaster information.	Iowa DOT, Iowa State Patrol, Story County Sheriff, City of Ames Police, Iowa State University Police, Boone County Sheriff, Boone County Emergency Management Agency, Story County Emergency Management	Existing/ Planned
Multi-Agency Limited Liability Agreements	Agreements will be developed to address the varying levels of liability limitation associated with the various agencies that would need to work together to enable coordinated, multi-agency transportation and emergency management strategies.	Agencies involved into transportation and emergency management.	Existing/ Planned
Transit Bus Signal Priority Agreement	Allow transit vehicles to activate signal priority at signalized intersections.	City of Ames CyRide, City of Ames Public Works	Planned
Emergency Vehicle Signal Preemption Agreement	Define roles, responsibilities and functions for emergency vehicle preemption at signalized intersections	City of Ames Public Works, City of Ames Police, City of Ames Fire, Marry Greeley Medical Center	Existing/ Planned
Railroad Crossing Management Agreement	Define roles, responsibilities and functions for rail grade crossing coordination and optimization at signalize intersections.	City of Ames Public Works, Union Pacific Railroad	Existing

11. USING REGIONAL ITS ARCHITECTURE

The AAMPO Regional ITS Architecture provides guidance for planning ITS projects within the region. A crucial part of developing an ITS Architecture is establishing an approach to using it. The AAMPO Regional ITS Architecture represents a detailed plan for the evolution of the ITS systems within the region. It provides information that can be used to support transportation planning efforts and ITS project development cycle.

A regional ITS architecture focuses on the integration of systems to gain the maximum benefit of each system's information and capabilities across the transportation network. The most challenging issue in the integration of an ITS architecture in the planning process is the fact that there is more than one planning process. Coordination among the AAMPO, the Central Iowa Region Transportation Planning Alliance (Regional Planning Affiliation 11), and the Iowa Department of Transportation for ITS projects in their respective plans is critical to the success of ITS planning, deployment, and integration. Integration opportunities should be taken advantage of within the region. This is the primary intent of the ITS architecture compliance where Federal funding is involved.

This section of the report presents the approach for integrating the regional ITS Architectures developed for the AAMPO into the transportation planning process and leveraging the ITS Architectures in project definition.

11.1 Support Transportation Planning Process

Once an ITS architecture has been created, it can be used as a key reference in the transportation planning process. This will ensure all proposed ITS projects are consistent with the ITS architecture and additional integration opportunities are considered, leading to more efficient implementations.

Long Range Transportation Plan

One of the principal planning documents is the Long Range Transportation Plan (LRTP). The LRTP is a long-range guide for major projects, systems, policies and strategies designed to maintain the existing multi-modal surface transportation system in the region and serve the region's future travel needs. The LRTP must be updated periodically. Serving as the MPO for the Ames urbanized area, AAMPO is responsible for developing and maintaining the AAMPO LRTP. The AAMPO LRTP for 2030 has been completed in 2005.

The AAMPO Regional ITS Architecture can serve as an input to the LRTP. The ITS services and projects identified in the regional ITS architecture can support the development of long-range and short-range strategies/actions during the LRTP planning that lead to an integrated, efficient inter-modal transportation system. The descriptions of the key goals and attributes of the systems and services included in the regional ITS architecture can support measurement assessment during the LRTP planning. The Project Sequencing from the regional ITS architecture can assist the development of prioritized projects and address the consistency of proposed transportation investments in the financial plan, which is typically a part of the LRTP. In addition, the regional ITS architecture provides a framework for analyzing how ITS elements

are related and thereby to identify the areas for potential coordination and cooperation among agencies. This can promote both systems and inter-jurisdictional integration during the LRTP planning.

Transportation Improvement Program

Transportation Improvement Program (TIP) is another primary transportation planning output that can be supported by the regional ITS architecture. The AAMPO TIP describes prioritized transportation projects funded with federal, state and local funds that will be deployed and/or operated over a three-year period. TIP is prepared every year and the projects in the TIP should be consistent with the LRTP.

As part of the TIP preparation, a project prioritization and selection process is conducted, where the AAMPO Regional ITS Architecture can play a role. The Project Sequencing output from the regional ITS architecture can be an input to prioritization. Integration opportunities identified in the regional ITS architecture can be used to better define the full benefits of ITS projects. In addition, some of the project description information might be available from the outputs of the regional ITS Architecture, specially the Project Sequencing output.

In addition to the LRTP and TIP planning, the regional ITS architecture can be considered to support other transportation planning activities or services associated with ITS projects or projects with ITS elements in the region.

11.2 Support ITS Project Development

The AAMPO Regional ITS Architecture can be used for support in ITS project development cycle. A typical ITS project development cycle begins with project definition, followed by Request for Proposal (RFP) generation, leading to project implementation. Information in the regional ITS architecture can assist in all three of these areas of project development.

Project Definition

Project Definition may occur at several levels of detail. Early in the planning process a project may be defined only in terms of the transportation services it will provide, or by the major system pieces it contains. At some point prior to the beginning of implementation the details of the project must be developed. This could include further system definition and interface definition including exactly what systems or parts of systems will make up the project, what interconnections the project entails, or what information needs to flow across the system interconnections. Requirement definition may go through similar levels of detail, starting with very high-level description of project functions and moving toward system specifications. By identifying the portions of the regional ITS architecture that define the project, the architecture outputs can be used to create aspects of the project definition.

The areas that a regional ITS architecture can assist in project definition are:

- The identification of agency roles and responsibilities (including any inter-agency cooperation) can come from the operational concept developed as part of the regional ITS

architecture. This operational concept can either serve as a starting point for a more detailed definition, or possibly provide all the needed information.

- Requirements definition can be completely or partly defined by using the regional ITS architecture functional requirements applicable to the project.
- The regional ITS architecture includes a map to ITS standards, and the project mapping to the regional ITS architecture can extract the applicable ITS standards for the project.

RFP Generation

Once a project is defined, and funding is committed, the implementation process can commence with the generation of a RFP, which is the common governmental practice for initiating a contract with the private sector to implement the project. Once a contract is in place, project implementation begins and moves through design, development, integration, and testing.

The regional ITS architecture, and the products produced during its development, can support this RFP generation. First the project definition described above forms the basis for what is being procured. Mapping the project to the regional ITS architecture allows bidders to have a clear understanding of the scope of the project and of the interfaces that need to be developed. The functional requirements created as part of the regional ITS architecture can be used to describe the functional requirements for the project. In addition a subset of the ITS Standards identified as part of the regional ITS architecture development can be specified in the RFP.

Project Implementation

Because ITS projects involve systems and their interconnections, it is very important to follow a systems engineering approach to designing and implementing the project. While the exact process followed is at the discretion of the local agency, the FHWA and FTA ITS Architecture and Standards Final Rule/Policy lay out a set of required systems engineering analyses for ITS projects funded through the highway trust fund. The required systems engineering analysis steps are:

- Identification of portions of the regional ITS architecture being implemented;
- Identification of participating agencies' roles and responsibilities;
- Requirements definitions;
- Analysis of alternative system configurations and technology options to meet requirements;
- Procurement options;
- Identification of applicable ITS standards and testing procedures; and
- Procedures and resources necessary for operations and management of the system.

The regional ITS architecture can provide inputs to a number of these steps as shown in Table 11-1.

Table 11-1. Systems Engineering Requirements Supported by Regional ITS Architecture

Systems Engineering Requirements	ITS Architecture Output
Identification of portions of the regional ITS architecture being implemented	Mapping the project to the elements and interfaces of the regional ITS architecture.
Identification of participating agencies' roles and responsibilities	Using Operational Concept as a starting point.
Requirements definitions	Using Functional Requirements as a starting point.
Identification of applicable ITS standards and testing procedures	Using architecture standards outputs as a starting point for the standards definition.

12. ARCHITECTURE MAINTENANCE PLAN

12.1 Introduction

The AAMPO Regional ITS Architecture has been created as a consensus view of what ITS systems the region's stakeholders have implemented and what systems they plan to implement in the future. By its nature, the architecture is not a static set of outputs. The architecture will be modified as plans and priorities change, ITS projects are implemented, and the ITS needs and services evolve in the region. There are many actions that may cause a need to update the architecture, including:

- **Changes in Project Definition.** When actually defined, a project may add, subtract or modify elements, interfaces, or information flows of the regional ITS architecture. Because the architecture is meant to describe not only ITS planned, but also the current ITS implementations, it should be updated to correctly reflect the deployed projects.
- **Changes due to Project Addition/Deletion.** Occasionally a project will be added, deleted or modified during the planning process. When this occurs, the aspects of the regional ITS architecture associated with the project should be added, deleted or modified.
- **Changes in Project Status.** As projects are deployed, the status of the architecture elements, services and flows that are part of the projects will have to be changed from planned to existing. Elements, services and flows should be considered to exist when they are substantially complete.
- **Changes in Project Priority.** Due to funding constraints, technological changes or other considerations, a project planned may be delayed or accelerated. Such changes should be reflected in the regional ITS architecture.
- **Changes in Regional Needs.** Transportation planning is done to address regional transportation needs. Over time these needs change and the corresponding aspects of the regional ITS architecture that addresses these needs may need to be updated.
- **Changes in Participating Stakeholders.** Stakeholder involvement can also change over time. The regional ITS architecture should be updated to reflect the participating stakeholder roles in the region view of ITS elements, interfaces, and information flows.
- **Changes in National ITS Architecture.** The National ITS Architecture may be expanded and evolved from time to time to include new user services or refine existing services. These changes should be considered as the regional ITS architecture is updated.

The following sections define the key aspects of the process for the maintenance of the AAMPO Regional ITS Architecture:

- Who is responsible for architecture maintenance?

- What will be maintained?
- How will it be maintained (i.e. what configuration control process will be used)?

12.2 Who Is Responsible for Architecture Maintenance

Responsibility for maintaining the AAMPO Regional ITS Architecture lies with the AAMPO. It is recommended that the AAMPO establishes an advisory group that reviews proposed changes to the architecture. This group may be called the Regional ITS Architecture Maintenance Advisory Team. The Advisory Team will be responsible for reviewing proposed changes. An opportunity should be given to the Advisory Team to review all proposed changes before any changes are accepted and the architecture is updated. The Advisory Team will meet on an annual basis, or more frequently as necessary, to review any proposed changes to the architecture.

The Chair of the Advisory Team or his/her designated representative will serve as the Maintenance Manager responsible for overseeing and guiding the maintenance effort. The Maintenance Manager will coordinate the activities of the architecture maintenance, including calling the meetings, making arrangements, assembling an agenda, leading the meetings, and approving minutes.

12.3 What Will Be Maintained

There are several different components that make up the AAMPO Regional ITS Architecture. Some may require more frequent updates than others, but the entire architecture will need periodic review to ensure that it is consistent with regional goals. This initial version (Version 1.0) of the AAMPO Regional ITS Architecture should be established as the baseline architecture, and the maintenance timeframe identified in this document will become effective upon completion of the architecture.

The AAMPO Regional ITS Architecture was developed using Turbo Architecture Software Version 3.1 and stored in an electronic Turbo Architecture database. The architecture is represented through a set of outputs including various reports and diagrams. Collectively these outputs can be used to develop a general ITS architecture document. The architecture will be maintained through updates in the electronic database using Turbo Architecture.

The following will be reviewed and updated as appropriate at regular intervals:

- Description of the region
- Participating agencies and other stakeholders, including key contact information
- Inventory of existing and planned ITS systems in the region
- Operational concept that identifies the roles and responsibilities of participating agencies and stakeholders in the operation and implementation of the systems
- Agreements for operations and interoperability
- System functional requirements
- Interface requirements and information exchanges with planned and existing systems and subsystems
- Applicable ITS standards supporting regional and national interoperability
- Sequence of projects for implementation

Outputs such as interconnect and architecture flow diagrams, inventory lists, stakeholders lists and other diagrams and reports can be produced from the Turbo Architecture software, so they are by-products of the architecture database. These outputs can be updated as necessary for meetings or outreach activities.

To aid the architecture version document control, it is recommended that the filename of the database should contain the version number and/or date on which the architecture was updated. Also the version number and date should be included in the Turbo Architecture database.

12.4 Configuration Control

Once the architecture baseline is defined, the process for making changes to this baseline must be established. The configuration control (change management) process specifies how changes are identified, how often changes are made, and how the changes will be reviewed, implemented, and released.

How Changes are identified

Changes to the AAMPO Regional ITS Architecture may be identified in two channels. One is that AAMPO proposes changes to the architecture according to the ITS projects or projects with ITS components within the region. Another channel is that any stakeholders identified as a participant in the regional ITS architecture may propose potential changes. If the proposed change is to add a new stakeholder and the stakeholder's ITS elements and interfaces, that agency should submit the change request. All change requests should be sent to the Maintenance Manager. The changes to the architecture, the reasons for the proposed modifications and the stakeholder contact should be clearly defined in the request. Upon receiving a change request, the Maintenance Manager will perform an initial assessment of the proposed change for the impact to the regional ITS architecture and/or the affected document. If the proposed change has an impact on other stakeholders, the Maintenance Manager should contact the stakeholders to confirm their agreement with the proposed modification.

How often Changes are made

A comprehensive, formal update of the AAMPO Regional ITS Architecture Baseline should be performed in corresponding with the LRTP updates. This architecture baseline update should be made within 6 months prior to the update of the LRTP. This will allow an updated version of the architecture to be used as the basis for the LRTP updates. This maintenance schedule will also ensure that the architecture continues to accurately represent regional goals. Minor, informal modifications may be made at the discretion of the Maintenance Manager, given the modifications are approved by the Architecture Maintenance Advisory Team.

Change Review, Implementation, and Release

The following general steps in the process of change review, implementation and release are recommended:

1. Stakeholders define and propose changes per the recommendations given above.
2. The Maintenance Manager, as necessary in coordination with the stakeholders affected by the proposed changes, evaluates the changes and determines what impact they may have on the architecture and/or associated documentation.
3. The Architecture Maintenance Advisory Team reviews the proposed changes and offers comments.
4. Upon its review, the Architecture Maintenance Advisory Team makes decisions to accept the change, reject it, or ask for additional information.
5. The Maintenance Manager implements the decisions. If the decision is to accept the change, then the appropriate portions of the architecture baseline are updated (per the schedule discussed above) and an updated architecture baseline is defined.
6. Once the regional ITS architecture has been modified, the stakeholders will be notified by the Maintenance Manager of architecture updates and informed on how to obtain the latest version of the architecture.

The time required to perform this configuration control process will be a direct function of the number of changes suggested to the architecture, which will be driven by how much the architecture is being used. This process should be reviewed periodically and fine-tuned to most appropriately address the level of change that has occurred.

13. GLOSSARY AND DEFINITION

Advanced Public Transportation System (APTS)

APTS involves the application and integration of existing and emerging technologies in the areas of communications, navigation, information processing, and control systems to improve the effectiveness of transit operations.

Advanced Traffic Management Systems (ATMS)

Systems, which collect, utilize, and disseminate real-time data on congestion on arterial streets and expressways, and will alert motorists of alternate routes. Components of an ATMS include CCTV monitoring, ramp metering, traffic signal control, vehicle detection, and communications.

Advanced Traveler Information Systems (ATIS)

Systems, which disseminate information to the traveling public over a variety of methods such as variable-message sign, kiosks, Internet, cable television, personal hand-held devices, etc.

Architecture Flow

Information that is exchanged between subsystems and terminators in the physical architecture view of the National ITS Architecture. Architecture flows are the primary tool that is used to define the Regional ITS Architecture interfaces. These architecture flows and their communication requirements define the interfaces which form the basis for much of the ongoing standards work in the national ITS program. The terms "information flow" and "architecture flow" are used interchangeably.

Architecture Interconnect

Communications paths that carry information between subsystems and terminators in the physical architecture view of the National ITS Architecture. Several different types of interconnects are defined in the National ITS Architecture to reflect the range of interface requirements in ITS.

Arterial (Non-Freeway) Traffic Management

Systems that monitor traffic flow on arterial street and non-freeway rural roadway systems and implement signal timing plans in order to optimize the progression of traffic, including coordination with railroad crossings.

Automated Vehicle Maintenance

This technology performs vehicle maintenance scheduling and manages both routine and corrective maintenance activities on vehicles and other maintenance and construction equipment. It includes on-board sensors capable of automatically performing diagnostics for maintenance and construction vehicles, and the systems that collect this diagnostic information and use it to schedule and manage vehicle maintenance.

Automatic Vehicle Location (AVL)

AVL systems enable the approximate location of a vehicle to be determined and tracked as it traverses the transportation network. The most common application of AVL technology is for dispatching emergency vehicles, tracking transit vehicles and providing passengers with arrival time estimations through information displays, and delivery companies.

Closed-Loop System

A system in which the computer controls an external process using information received from the process—e.g., the closed loop in a traffic signal control system is from the computer to the controllers affecting the vehicular traffic and sensed by the traffic detectors and this information sent to the computer.

Computer-Aided Dispatch (CAD)

An "intelligent" interactive mapping and data entry system to dispatch, monitor, and manage emergency services. The emergency-dispatching hub uses a database and configuration tools in which an agency can store, use, and report on information such as incident histories, unit activities, etc., in a way that is logical and useful to the dispatcher and administrator.

Commercial Vehicle Operations (CVO)

Systems that support administrative functions for commercial vehicle operations, including credentialing, taxing, and enforcement of safety regulations, as well as oversize/overweight and HAZMAT permitting.

Dedicated Short Range Communications

A wireless communications channel used for close-proximity communications between vehicles and the immediate infrastructure. It supports location-specific communications for ITS capabilities such as toll collection, transit vehicle management, driver information, and automated commercial vehicle operations.

Dynamic Message Sign (DMS)

A sign that uses electronics or mechanics to vary the visual word, number, or symbolic display as traffic conditions warrant. The term is used interchangeably with variable message sign (VMS) and changeable message sign (CMS).

Element

This is the basic building block of Regional ITS Architectures and Project ITS Architectures. It is the name used by stakeholders to describe a system or piece of a system.

Emergency Vehicle Preemption (EVP)

This technology allows emergency vehicles (police, fire trucks, ambulances, etc.) to intervene in the normal operation of traffic control systems using wireless communications installed on traffic intersections and emergency vehicles. As the emergency vehicle approaches a traffic signal, it is recognized by the traffic signal controller through light, radio waves, or sound. The normal green-yellow-and-red cycle can then be interrupted to change the light to green.

Environmental Sensor Stations

A specific type of roadway equipment that monitors pollution, emissions, weather, roadway surface, and air/water quality conditions. The environmental sensor station is comprised of a remote processor unit connected to one or more sensors that collect environmental or meteorological data. It collects weather data such as air temperature, amount and type of precipitation, visibility, dew point, relative humidity, wind speed, and wind direction. It also collects surface conditions, including pavement temperature, subsurface temperature, surface conditions (dry, wet, or frozen), amount of deicing material, and freezing point on the road

surface. The primary users of the information from these devices are roadway maintenance and traffic operations.

Equipment Package

Equipment packages are the building blocks of the physical architecture subsystems. Equipment Packages group similar processes of a particular subsystem together into an “implementable” package. The grouping also takes into account the user services and the need to accommodate various levels of functionality. The equipment packages were used as a basis for estimating deployment costs (as part of the evaluation that was performed).

Fixed-Point to Fixed-Point Communications

A communication link serving stationary entities. It may be implemented using a variety of public or private communication networks and technologies. It can include, but is not limited to, twisted pair, coaxial cable, fiber optic, microwave relay networks, spread spectrum, etc.

Freeway Management Systems

Freeway management systems provide real-time control, guidance, warning, and management of traffic in order to improve flow of people and goods safely and efficiently.

HAZMAT Detection

This technology provides the capability to detect and classify security sensitive hazardous materials on commercial vehicles using roadside sensing and imaging technology.

Incident Detection

Incident Detection provides the capability to traffic managers to detect and verify incidents. This capability includes analyzing and reducing the collected data from traffic surveillance equipment, monitoring external alerting and advisory and incident reporting systems, collecting special event information, and monitoring for incidents and hazardous conditions through available sensor and surveillance systems.

Incident/Emergency Management

A system that enables communities to quickly identify crashes/breakdowns and ensure agency coordination so that the closest available and most appropriate emergency unit can be dispatched to minimize clean-up and medical response time.

Intelligent Transportation Systems (ITS)

ITS applies state-of-the-art and emerging technologies to provide more efficient and effective solutions to current multimodal transportation problems. Some examples of ITS are ramp metering, variable-message signs, closed-circuit television monitoring system, and traffic signal systems.

ITS Architecture

A common framework for planning, defining, and integrating intelligent transportation systems. An architecture functionally defines what the pieces of the system are and the information that is exchanged between them. An architecture is functionally oriented and not technology-specific which allows the architecture to remain effective over time. It defines "what must be done," not "how it will be done."

Maintenance and Construction Operations (MCO)

MCO functions to support monitoring, operating, maintaining, improving and managing the physical condition of roadways, the associated infrastructure equipment, and the required resources.

Market Package

The market packages provide an accessible, service-oriented perspective to the National ITS Architecture. They are tailored to fit, separately or in combination, real world transportation problems and needs. Market packages collect together one or more equipment packages that must work together to deliver a given transportation service and the architecture flows that connect them and other important external systems.

On Board Security Monitoring System

On board security monitoring system provides security and safety functions on-board the transit vehicle. This includes surveillance and sensors to monitor the on-board environment, silent alarms that can be activated by transit user or vehicle operator, operator authentication, and a remote vehicle disable function. The surveillance equipment includes video (e.g. CCTV cameras), audio systems and/or event recorder systems. The sensor equipment includes threat sensors (e.g. chemical agent, toxic industrial chemical, biological, explosives, and radiological sensors) and object detection sensors (e.g. metal detectors).

Physical Architecture

The physical architecture is the part of the National ITS Architecture that provides agencies with a physical representation (though not a detailed design) of the important ITS interfaces and major system components. It provides a high-level structure around the processes and data flows defined in the logical architecture.

Regional ITS Architecture

A specific, tailored framework for ensuring institutional agreement and technical integration for the implementation of ITS projects or groups of projects in a particular region. It functionally defines what pieces of the system are linked to others and what information is exchanged between them.

Road Weather Information System (RWIS)

A system consisting of meteorological components strategically located alongside the highway, which allow the owner to make more informed decision during winter storms. Specialized equipment and computer programs monitor air and pavement temperature to make forecasts regarding how the winter storms impact the highways. The principal components of RWIS include pavement sensors, atmospheric sensors, remote processing unit (RPU), and central processing unit (CPU).

Security Sensors and Surveillance Equipment

This technology includes cameras and sensors to monitor transportation infrastructure (e.g., bridges, tunnels and management centers) to detect potential threats. Such equipment includes acoustic, environmental threat (nuclear, explosive, chemical), motion and object sensors, and video and audio surveillance.

Standards

Documented technical specifications sponsored by a Standards Development Organization (SDO) to be used consistently as rules, guidelines, or definitions of characteristics for the interchange of data.

Subsystem

The principle structural element of the physical architecture view of the National ITS Architecture. Subsystems are individual pieces of the Intelligent Transportation System defined by the National ITS Architecture. Subsystems are grouped into four classes: Centers, Field, Vehicles, and Travelers.

Terminator

Terminators define the boundary of an architecture. The National ITS Architecture terminators represent the people, systems, and general environment that interface to ITS.

Transit Signal Priority

Transit signal priority is an operational strategy that facilitates the movement of in-service transit vehicles through traffic-signal controlled intersections. Transit signal priority modifies the normal signal operation process to better accommodate transit vehicles. The objectives of transit signal priority include improved schedule adherence, improved transit efficiency, contribution to enhanced transit information, and increased road network efficiency.

Turbo Architecture

An automated software tool used to input and manage system inventory, market packages, architecture flows and interconnects with regard to a Regional ITS Architecture and/or multiple Project ITS Architectures.

Weigh In Motion (WIM)

Various technologies that enable vehicle weights to be determined without the need for a vehicle to physically stop on a scale. High-speed WIM enables trucks to be weighed at highway speed with or without Automated Vehicle Identification (AVI) capabilities.